

EVOLUTION

FLIGHT DISPLAY

EFD1000 PFD Pilot's Guide

ASPEN  AVIONICS™

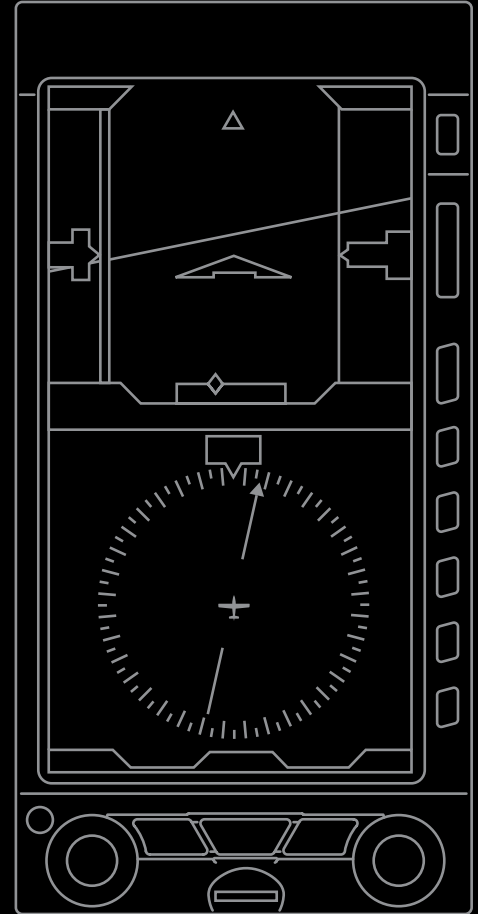

EVOLUTION

FLIGHT DISPLAY

EFD1000 PFD Pilot's Guide

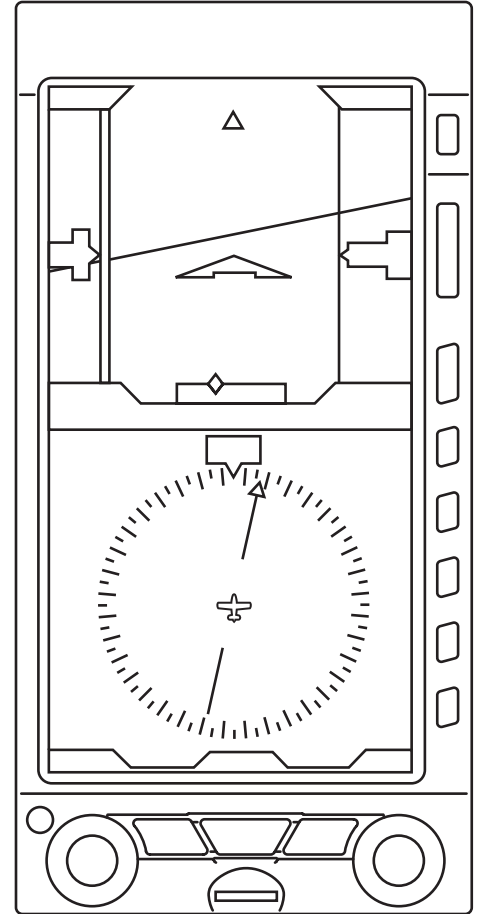

Document Revisions

REVISION	DESCRIPTION of CHANGE
E	<p>Deleted from the Table of Contents: Table of Figures, Table of Tables, and Table of Tasks; Added Evolution Databases to Chapters 1 & 7; Grammatical, pictorial, and technical updates. Revised to update for software v2.3.1, and v2.4.1.</p> <p>Software v2.3.1 include the following:</p> <ul style="list-style-type: none"> • Knob function improvements • BARO function moved to dedicated Hot Key preventing inadvertent adjustment • Map Declutter function removed from Hot Key to the MENU Map Settings page • Support for ADF1 and ADF2 Bearing Pointer sources • Support for Radio Altitude Display • MINIMUMS annunciation relocated to Selected Minimums Field • Battery annunciation relocated to top left corner below Selected Airspeed Field • Overvoltage protection whenever aircraft's electrical system generates more than 33 volts, PFD automatically switches to its battery power • Support for Redline or Barber pole airspeed limits that vary with pressure altitude • Support for MACH number displayed in Data Bar for Mmo aircraft • Single dedicated Hot Key for Traffic Overlay and Traffic Altitude Filter when configured with optional EHA • RSM GPS can be configured to share its position among all Evolution Displays when all the panel-mounted GPS units fail <p>Software v2.4.1 include the following:</p> <ul style="list-style-type: none"> • Hot Key Color Legend improvements • "ON" setting removed from Flight Plan, Airports, VOR, and Intersections/NDB Basemap features

REVISION	DESCRIPTION of CHANGE
D	Updated for software v2.2 and v2.2.3 Grammatical, pictorial, and technical updates
C	Updated for software v2.1
B	Grammatical, pictorial, and technical updates Added Index.
A	<p>Using new part number 091-00005-001</p> <p>Grammatical, pictorial, and technical updates. Revised to update for software v2.0, including the following:</p> <ul style="list-style-type: none"> • All images updated with v2.0 images • Updated Color philosophy • Annotate features unavailable on EFD1000 Pilot PFD • Hot Key update. Menu update • Added Altitude Trend Vector • Added Minimums Marker • Updated range settings; 2 and 3 NM, delete 2.5 NM • Added ability to select Celsius or Fahrenheit units of measure for OAT • Entire Emergency and Abnormal Procedures Chapter updated • Added Map Auto Range • Updated Vspeed configuration • Added additional GPSS information • Addition of Hazard Awareness options, WX-500/Lightning, Data Link Weather, and Traffic

REVISION	DESCRIPTION of CHANGE
C* ()	<p data-bbox="235 152 1193 175">**Part number change: old part number A-01-184-00 REV C; new part number 091-00005-001 REV ().</p> <p data-bbox="235 202 1372 225">Grammatical, pictorial, and technical corrections and updates. Revised to update for software version 1.1, which include:</p> <ul data-bbox="284 242 1331 553" style="list-style-type: none"> • New start-up splash screen • Failure message for RSM and Config Module link • Brightness changes • Auto brightness range 1% - 70% • Manual brightness range 1% - 100% • During internal battery operation, brightness capped at 40% for Auto mode and 70% for Manual mode • When temperature is above $\geq 70^{\circ}$ C, brightness capped at 30% for Auto mode and 70% for Manual mode • Menu, System Status Page added Unit S/N • Wind Speed and Direction Degrees do not display when • When aircraft is on the ground • When wind speed is ≤ 10. Additionally, the Wind Arrow does not display <p data-bbox="235 569 641 592">Added Title page, Revision page and Index</p>
B	Layout Update
A	Initial Release
* Legacy P/N revision is displayed above the new CI number Revision	

Table of Contents

Document Revisions	iv
Copyrights, Trademarks and Patents	xi
Approvals	xii
LIMITED WARRANTY Aspen Avionics, Inc.	xiii
Weather Data Warranty	xvi
XM WX Satellite Radio Service Agreement	xvii
Conventions.....	xix
Covered Functionality.....	xix
Terminology	xix
Color Philosophy.....	xxi
Warnings, Cautions, and Notes.....	xxii
Example Graphics	xxiii
Pilot Familiarity.....	xxiii
Information Covered in this Pilot's Guide	xxiv

Chapter 1

Welcome and Introduction..... 1-1

1.1. System Overview.....	1-4
1.1.1. Primary Flight Display Unit (PFD)	1-5
1.1.2. Configuration Module (CM)	1-6
1.1.3. Analog Converter Unit (ACU) ¹	1-6
1.1.4. Remote Sensor Module (RSM)	1-7
1.1.5. Evolution Weather Receiver (EWR50) ¹	1-7
1.1.6. Evolution Databases.....	1-8

Chapter 2

Controls and Display 2-1

2.1. Controls & Display Orientation	2-2
2.2. Controls.....	2-4
2.2.1. Left and Right Knobs	2-4
2.2.1.1. Left Knob Functions.....	2-5
2.2.1.2. Right Knob Functions	2-5
2.2.1.3. SYNC Function.....	2-6
2.2.1.4. Using the Knobs (Example)	2-8
2.2.2. Navigation Source Select Buttons ¹	2-8
2.2.2.1. CDI Navigation Source Select Button ¹	2-9
2.2.2.2. Bearing Pointer Source Select Buttons ¹	2-10
2.2.3. Hot Keys.....	2-11
2.2.4. Menu.....	2-14
2.2.4.1. Using the Menus.....	2-14
2.2.4.2. Display Lighting	2-18
2.2.5. Range Buttons.....	2-19
2.2.6. REV Button.....	2-19
2.3. Display.....	2-20
2.3.1. Cleaning the Display Screen.....	2-21
2.3.2. Attitude Display.....	2-22
2.3.2.1. Attitude Director Indicator (ADI).....	2-24
2.3.2.2. Airspeed Tape and Bug	2-25
2.3.2.2.a. Mach Number Display for Mmo Aircraft.....	2-26
2.3.2.3. Altitude Tape, Altitude Alerter, and Vertical Speed.....	2-27

2.3.2.4. Instrument Approach Indicators ¹	2-28
2.3.3. Data Bar	2-29
2.3.4. Navigation Display	2-30
2.3.4.1. Numerical Direction Indicator (Magnetic Compass)	2-32
<i>Compass Modes: 360° vs. ARC</i>	2-32
<i>Navigation Information</i>	2-33
2.3.4.2. Horizontal Situation Indicator (HSI) ¹	2-34
2.3.4.3. Course Pointer and Course Deviation Indicator (CDI) ¹	2-34
2.3.4.4. Deviation Off-Scale Indication ¹	2-35
2.3.4.5. Auto Course Select ¹	2-35
2.3.4.6. Bearing Pointers ¹	2-36
2.3.4.7. Rate of Turn Indicator	2-37
2.3.4.8. Vertical Speed Indicator (VSI)	2-37
2.3.4.9. Situational Awareness Map	2-38

Chapter 3 Flying the Pro PFD 3-1

3.1. Quick Controls Overview	3-3
3.2. Example Flight Scenario	3-5
3.2.1. Pre-Departure (Startup)	3-6
3.2.2. Departure	3-17
3.2.3. Enroute	3-19
3.2.4. Arrival and Approach to Landing	3-22
3.3. Conclusion	3-27

Chapter 4 Reference Guide 4-1

4.1. Air Data, Attitude and Heading Reference System (ADAHRS) ..	4-2
4.1.1. Attitude	4-3
4.1.2. Pitot Obstruction Monitor	4-4
4.1.3. Heading	4-5
4.1.4. Free Gyro Mode	4-6
4.1.5. Degraded ADAHRS Performance	4-7
4.2. Attitude Display	4-8
4.2.1. Attitude Indicator	4-8
4.2.1.1. Roll Scale	4-9
4.2.1.2. Pitch Scale	4-9
4.2.1.3. Slip/Skid Indicator	4-9
4.2.1.4. Flight Director ¹	4-9
4.2.2. Airspeed Indicator	4-10
4.2.2.1. Selected Airspeed	4-12
4.2.2.2. Airspeed Display	4-13
4.2.2.3. MACH Number Display for Mmo Aircraft	4-14
4.2.3. Altimeter	4-15
4.2.3.1. Barometric Units of Measure	4-16
4.2.3.2. Selected Altitude Field	4-17
4.2.3.3. Altitude Level-Off and Deviation Alert	4-18
4.2.3.4. MINIMUMS Annunciation ¹	4-19
4.2.3.5. Radio Altitude Display ¹	4-22
4.2.3.6. Altitude Display	4-23
4.3. Data Bar	4-24

4.3.1. True Airspeed or Mach Number (when enabled).....	4-24	4.4.15. Course Pointer Operation with Integrated VOR/ Localizer/GPS Navigation Systems ¹	4-49
4.3.2. Ground Speed	4-25	4.5. Lateral and Vertical Deviation Indicator ¹	4-50
4.3.3. Outside Air Temperature (when enabled)	4-25	4.5.1. Lateral Deviation Indicator ¹	4-50
4.3.4. Wind Speed, Direction, and Arrow (when enabled) ...	4-26	4.5.2. Vertical Deviation Indicator ¹	4-51
4.3.5. Barometric Pressure Setting Display.....	4-26	4.6. Vertical Speed Indicator	4-52
4.4. Navigation Display.....	4-27	4.7. Autopilot Integration ¹	4-53
4.4.1. Compass	4-28	4.7.1. GPS Steering (GPSS) ¹	4-54
4.4.1.1. 360° Compass Mode.....	4-28	4.7.2. Flight Director ¹	4-58
4.4.1.2. ARC Compass Mode	4-28	4.7.3. Typical Autopilot Operations ¹	4-58
4.4.2. Course Pointer ¹	4-31	4.8. Hazard Awareness ¹	4-65
4.4.3. TO/FROM Indicator ¹	4-32	4.8.1. Lightning Overlay ¹	4-65
4.4.4. Course Deviation Indicator and Scale ¹	4-33	4.8.2. Data Link Weather Overlay ¹	4-67
4.4.4.a. Localizer Back Course (BC) Operation ¹	4-34	4.8.3. Traffic Overlay ¹	4-71
4.4.5. CDI Navigation Source ¹	4-34	4.8.3.1. Traffic Symbols ¹	4-72
4.4.6. Auto Course ¹	4-38	4.8.3.2. Traffic Altitude Filter ¹	4-74
4.4.7. CDI Selected Course ¹	4-39	4.8.3.3. Traffic Unavailable ¹	4-75
4.4.8. Bearing Pointer Source Selection ¹	4-40		
4.4.9. Heading Bug.....	4-43	Chapter 5	
4.4.10. Aircraft Heading Display	4-44	Customizing the PFD	5-1
4.4.11. Rate of Turn Indicator	4-44	5.1. Menu Overview.....	5-1
4.4.12. Basemap Overlays	4-45	5.2. Customizing Basemap Symbol Declutter Settings	5-12
4.4.12.1. Basemap Declutter and Range.....	4-46	5.3. Configuring Vspeeds.....	5-15
4.4.12.2. Flight Plan ¹	4-48	5.4. LCD Brightness Control.....	5-20
4.4.12.3. Map Data Source and Reversion ¹	4-48		
4.4.13. Ground Track Marker ¹	4-49		
4.4.14. GPS OBS Operation with a PFD and a Mechanical Standby Nav Indicator ¹	4-49		

Chapter 6

Expanded Emergency and Abnormal Procedures 6-1

6.1. Pitot/Static System Blockage	6-2
6.1.1. Identifying and Handling Suspected Pitot and/or Static System Failures	6-4
6.2. Frequent or Persistent CROSS CHECK ATTITUDE Annunciation	6-7
6.3. Difference Detected Between the PFD and Mechanical Attitude Indicators	6-7
6.4. Abnormal Shutdown Procedure.....	6-8
6.5. Loss of Aircraft Electrical Power	6-9
6.5.1. Overvoltage Protection.....	6-11
6.6. GPS Failures and RSM Emergency GPS Use ¹	6-11
6.7. Power Override.....	6-13
6.8. In-Flight AHRS Reset.....	6-14
6.9. GPSS Operation, Annunciations, and Autopilot Modes ¹	6-16
6.10. Warning, Caution, and Advisory Summary	6-18

Chapter 7

Appendices 7-1

7.1. Operating Limitations.....	7-1
7.2. Software Versions and Serial Number	7-1
7.3. Evolution Database	7-3
7.3.1.1. Jeppesen Subscription	7-4

7.3.1.2. Monthly Jeppesen Updates.....	7-5
7.3.2. Seattle Avionics Software Database	7-6
7.3.2.1. Seattle Avionics Subscription	7-6
7.3.2.2. Seattle Avionics Software Updates.....	7-7
7.4. MicroSD Card	7-7
7.4.1. Loading the microSD Card into the EFD Unit.....	7-8
7.4.2. Card Installation Procedure and Operational Check....	7-8
7.4.3. Removal Procedure	7-9
7.5. Specifications.....	7-10
7.5.1. Primary Flight Display Unit (PFD)	7-10
7.5.2. Remote Sensor Module (RSM)	7-12
7.5.3. Analog Converter Unit (ACU)	7-12
7.5.4. Operational Specifications	7-13
7.6. Glossary	7-14
7.7. Index.....	7-18

Copyrights, Trademarks and Patents

Copyright 2007-2012.

Aspen Avionics® is a registered trademark of Aspen Avionics, Inc. Evolution™, EFD1000 Pro PFD™, EFD1000 MFD™, EFD500 MFD™, EFD1000™, EFD500™, and the Aspen Avionics logo are trademarks of Aspen Avionics, Inc. These trademarks may not be used without the express permission of Aspen Avionics, Inc. All rights reserved.

All other trademarks are the property of their respective companies. No part of the Pilot's Guide may be reproduced, copied, stored, transmitted, or disseminated, for any reason, without the express written permission of Aspen Avionics, Inc. Aspen Avionics hereby grants permission to download a single copy, and any revision, of the Pilot's Guide onto a hard drive or other electronic storage medium for personal use, provided that such electronic or printed copy of the Pilot's Guide or revision must contain the complete text of this copyright notice and provided further that any unauthorized commercial distribution of the Pilot's Guide or revision hereto is strictly prohibited.

The Aspen Avionics EFD1000 Pro PFD when configured with the Evolution Hazard Awareness options provides access to information from multiple sources. Aspen Avionics does not control, edit, or review the content of said information and, as such, is not responsible for information or the actions or conduct of any company that provides weather data used by the Aspen Avionics EFD1000 Pro PFD. Therefore, although Aspen Avionics strives to provide the highest quality service, ALL SERVICES AND WEATHER DATA ARE PROVIDED AS-IS and neither Aspen Avionics nor its suppliers, subcontractors, information sources or

developers (collectively called "Suppliers") are responsible for 1) the accuracy, completeness, timeliness, reliability, content, or availability of the Services or any information accessed; 2) loss or damage to your records or data; or 3) your use of, or results achieved from, the Services or any information accessed.

Avidyne® is a registered trademark of Avidyne Corporation; Bendix/King® is a registered trademark of Honeywell; Garmin GTX™ is a trademark of Garmin International, Inc.; NavData® is a registered trademark of Jeppesen, Inc.; SkyWatch® is a registered trademark of L-3 Communications; Stormscope® WX-500 is a registered trademark of BFGoodrich Avionics Systems, Inc.; and XM is a registered trademark of XM Satellite Radio, Inc.

The EFD1000, EFD1000C3, EFD1000H, EFD500, and EFD500H, and derivatives thereof, are protected under U.S. Patent Number 8,085,168 and additional patents pending.

Approvals

The FAA and the EASA (European Aviation Safety Agency) has approved the EFD1000 PFD under the following TSOs and ETSOs:

FAA TSO (Technical Standard Order)

TSO-C2d, TSO-C3d, TSO-C4c, TSO-C6d, TSO-C8d, TSO-C10b, TSO-C106, TSO-C113

EASA ETSO (European Technical Standard Order)

ETSO-C2D, ETSO-C3D, ETSO-C4C, ETSO-C6D, ETSO-C8D, ETSO-C10B, ETSO-C106, ETSO-C113

The following certification levels also apply to this product:

- Environmental Certification Level: RTCA DO-160E
- Software Certification Level: RTCA DO-178B Level C

This Pilot's Guide provides information on the use and operation of the Evolution Flight Display 1000 Primary Flight Display (EFD1000 PFD). This guide is current as of the latest revision listed on the Document Revisions page. Specifications and operational details are subject to change without notice when using an earlier or later software version. Please visit the Aspen Avionics web site for the most up-to-date Pilot's Guide.

Installation of the EFD1000 PFD in a type-certificated aircraft must be performed in accordance with the latest revision of the EFD1000 and EFD500 Installation Manual.

Aspen Avionics, Inc.
5001 Indian School Road NE
Albuquerque, NM 87110

Phone: (505) 856-5034
Fax: (505) 314-5440

www.aspenavionics.com

LIMITED WARRANTY

Aspen Avionics, Inc.

1. **YOUR WARRANTY.** Aspen Avionics, Inc. (“Aspen”) warrants to you, the original purchaser, that its Products (if purchased from an authorized dealer) will comply with applicable specifications (as set forth in the owner’s manual) in all material respects and will be free from material defects in workmanship or materials for a period of twenty-four (24) months beginning with the date that the aircraft in which the Product has been installed has been returned to service following installation by an Aspen authorized dealer (“Return to Service Date”). “Product” means new end equipment or hardware items, replaceable units and components of those units.
2. **YOUR REMEDY.** During the term of this warranty, Aspen will repair or replace, at its discretion, without charge (see Section 13 below for information on covered transportation costs), any Product that does not comply with the warranty of Section 1 above (a “Nonconforming Product”), so long as the warranty claim is timely submitted and the procedures in Section 14 (below) are followed. Aspen warrants repaired and/or replacement items only for the unexpired portion of the original warranty period, or, if the warranty has expired, for six months from Aspen’s shipment of the repaired or replacement Product.
3. **CONDITIONS TO COVERAGE.** Aspen’s obligation under this warranty is conditioned on your fulfillment of the obligation to:
 - A. Maintain records accurately reflecting operating time of and maintenance performed on the Product,
 - B. Furnish proof sufficient to establish that the item is a Nonconforming Product, and
 - C. Allow Aspen access to all relevant records in order to substantiate your warranty claim.
4. **EXCLUSIONS.** The following are not covered by (and are expressly excluded from) this warranty:
 - A. Normal wear and tear and the need for regular overhaul and maintenance,
 - B. Exposure of the Product to temperature, environmental, operating, or other conditions other than those prescribed in the owner’s manual,
 - C. Failure to install or operate the Product as prescribed in the owner’s manual or as Aspen otherwise directs,
 - D. Alterations or repairs made by anyone other than Aspen or its authorized service center,
 - E. Maintenance, repair, installation, handling, transportation, storage, operation (including, without limitation, operation of the product’s software or host medium), or use which is improper or otherwise does not comply with Aspen’s instructions as set forth in the owner’s manual,

- F. Accident, contamination, damage from a foreign object or weather conditions, abuse, misuse, neglect, or negligence,
- G. Exposure of the product or the product's host medium to any computer virus or other intentionally disruptive, destructive, or disabling computer code, and
- H. Any damage precipitated by failure of a product Aspen has supplied that is not under warranty or by any product supplied by someone else.

5. **INVALIDATION OF WARRANTY.** This warranty is void if the product is altered or repair is attempted or made by anyone other than Aspen or its authorized service center.

6. **WARRANTY CARD.** The Return to Service Date must be included in an accurately completed Aspen warranty application form submitted by the installing authorized dealer within 30 days of the Return to Service Date. The warranty application must be signed by the authorized repairman who certifies that the equipment has been safely and properly installed in accordance with all Aspen supplied technical information and in accordance with all applicable FAA procedures and requirements. The warranty application form must note the repairman's FAA certificate number to be valid. FAILURE TO COMPLETE AND RETURN THE WARRANTY CARD MAY RESULT IN DENIAL OF WARRANTY CLAIMS. MAKING CERTAIN THAT THE WARRANTY CARD IS COMPLETED, SIGNED, AND RETURNED IS YOUR RESPONSIBILITY.

7. **SOLE REMEDY.** Aspen's sole obligation, and your exclusive remedy under this warranty, is limited to either the repair or replacement, at Aspen's option, of any Nonconforming Product as provided herein.

8. **EXCLUSIVE WARRANTY.** THIS WARRANTY IS EXCLUSIVE AND IN LIEU OF ALL OTHER WARRANTIES. THE IMPLIED WARRANTY OF MERCHANTABILITY AND IMPLIED WARRANTY OF FITNESS FOR A PARTICULAR PURPOSE, AS WELL AS ALL OTHER IMPLIED WARRANTIES (STATUTORY OR OTHERWISE) EXPIRE AT THE END OF THE WARRANTY PERIOD PRESCRIBED IN SECTION 1.

Some States do not allow limitations on how long an implied warranty lasts, so the above limitation may not apply to you.

9. **INCIDENTAL DAMAGES.** ASPEN SHALL NOT UNDER ANY CIRCUMSTANCES BE LIABLE FOR ANY SPECIAL, DIRECT, INDIRECT, INCIDENTAL OR CONSEQUENTIAL LOSS OR DAMAGES OF ANY KIND (INCLUDING WITHOUT LIMITATION: DAMAGES FOR LOSS OF PROFITS, LOSS OF REVENUES, OR LOSS OF USE OR BUSINESS INTERRUPTION), EVEN IF ASPEN HAS BEEN ADVISED OF THE POSSIBILITY OR CERTAINTY OF THOSE DAMAGES OR IF ASPEN COULD HAVE REASONABLY FORESEEN THOSE DAMAGES.

Some states do not allow the exclusion of incidental or consequential damages, so the preceding limitations may not apply to you.

10. **LIMITATION OF LIABILITY.** ASPEN'S AGGREGATE LIABILITY HEREUNDER, WHETHER BASED UPON CONTRACT, TORT (INCLUDING NEGLIGENCE AND STRICT LIABILITY), INDEMNITY, OR OTHERWISE, WILL NOT EXCEED THE PRICE PAID BY YOU FOR THE WARRANTED PRODUCT. THE EXCLUSIONS OF TYPES OF DAMAGES CONTAINED HEREIN WILL BE DEEMED INDEPENDENT OF, AND WILL SURVIVE, ANY FAILURE OF THE ESSENTIAL PURPOSE OF ANY LIMITED REMEDY UNDER THE TERMS OF ANY AGREEMENT.

11. **EXTENSION OF WARRANTY.** No extension of this warranty will be binding upon Aspen unless set forth in writing and signed by Aspen's authorized representative.

12. **DEALER WARRANTIES.** Any express or implied warranty or remedy in addition to or different from those stated herein that is offered by a dealer ("Dealer Warranty") will be the sole responsibility of the dealer, who will be solely responsible for all liability, loss, cost, damage, or expense arising out of or in connection with any such Dealer Warranty. Although Aspen provides training and assistance to dealers, it cannot control the installation of its Products by its dealers, which are independent businesses not owned or controlled by Aspen.

13. **TRANSPORTATION COSTS.** Aspen will assume round trip transportation costs for a Product determined by Aspen to be a Nonconforming Product in an amount not to exceed normal (non express) shipping charges within the continental United States. You are responsible for all import/export fees, taxes, duties, customs, documentation fees, clearance fees, and similar fees and charges. You may contact Aspen to obtain a freight courier account number for prepaid shipping of the return. If Aspen subsequently determines that the Product is not a Nonconforming Product, that this warranty is inapplicable, that the Product is out of warranty, that the defect or malfunction is excluded from coverage, or that the warranty is invalid, Aspen will invoice you for repair or replacement costs and the shipping costs. Risk of loss or damage for any Product in transit will be borne by the party initiating the transportation.

14. **WARRANTY PROCEDURE.** If you require warranty service, you may contact your local Aspen Authorized Dealer or you may contact Aspen directly as described below. An original or copy of the sales receipt from the original Aspen Authorized dealer will be required to obtain any warranty service. You may contact Aspen for warranty service directly by calling Aspen Customer Service at (505) 856-5034; by writing to Aspen Customer Service Department, Aspen Avionics, Inc., 5001 Indian School Road NE, Albuquerque, New Mexico, 87110; or by visiting the Aspen Website at <http://www.aspenavionics.com>.

This warranty gives you specific legal rights, and you may also have other rights, which vary from State to State.

Weather Data Warranty

THE WEATHER DATA SOFTWARE PRODUCT IS PROVIDED "AS IS." ALL OTHER WARRANTIES, EXPRESSED OR IMPLIED, INCLUDING ANY WARRANTY OF MERCHANTABILITY OR FITNESS FOR A PARTICULAR PURPOSE OR OF NON-INFRINGEMENT ARE HEREBY EXCLUDED.

PILOT SAFETY.

If you use XM Services, it is your responsibility to exercise prudent discretion and observe all safety measures required by law and your own common sense. You assume the entire risk related to your use of the Services. XM and Aspen assume no responsibility for accidents resulting from or associated with use of the Services. Your Radio Service includes weather information, and you acknowledge that such information is not for "safety for life," but is merely supplemental and advisory in nature, and therefore cannot be relied upon as safety-critical in connection with any aircraft. This information is provided "as is" and XM and Aspen disclaim any and all warranties, express and implied, with respect thereto or the transmission or reception thereof. XM and Aspen further do not warrant the accuracy, disclosed on the Radio Service. In no event will XM and Aspen, their data suppliers, service providers, marketing/distribution, software or Internet partners or hardware manufacturers be liable to you or to any third party for any direct, indirect, incidental, consequential, special, exemplary or punitive damages or lost profits resulting from use of or interruptions in the transmission or reception of the Services.

LIMITS ON OUR RESPONSIBILITY

- A. **DISCLAIMERS.** EXCEPT AS EXPRESSLY PROVIDED HEREIN, WE MAKE NO WARRANTY OR REPRESENTATION, EITHER EXPRESS OR IMPLIED, REGARDING THE RADIO SERVICE. YOUR USE OF THE SERVICE IS AT YOUR SOLE RISK. THE CONTENT AND FUNCTIONALITY OF THE SERVICE IS PROVIDED "AS IS" WITHOUT ANY WARRANTY OF ANY KIND, EXPRESS OR IMPLIED. ALL SUCH WARRANTIES OR REPRESENTATIONS (INCLUDING, WITHOUT LIMITATION, THE IMPLIED WARRANTIES OF MERCHANTABILITY, FITNESS FOR A PARTICULAR PURPOSE, TITLE AND NON-INFRINGEMENT) ARE HEREBY DISCLAIMED.
- B. **LIMITATIONS OF LIABILITY.** WE ARE NOT RESPONSIBLE FOR ANY SPECIAL, INCIDENTAL, OR CONSEQUENTIAL DAMAGES OR LOSSES RELATING TO THE USE OF THE RADIO SERVICE, WHETHER BASED ON NEGLIGENCE OR OTHERWISE. OUR TOTAL LIABILITY TO YOU AND ANY OTHER PERSONS RECEIVING OUR SERVICES, REGARDLESS OF THE CAUSE, WILL IN NO EVENT EXCEED THE AMOUNTS THAT YOU HAVE PAID TO US FOR THE SERVICE THAT YOU RECEIVED DURING THE SIX (6) MONTH PERIOD IMMEDIATELY PRIOR TO THE SPECIFIC EVENT THAT GAVE RISE TO THE APPLICABLE DAMAGE OR LOSS. THIS ALLOCATION OF RISK IS REFLECTED IN OUR PRICES. YOU MAY HAVE GREATER RIGHTS THAN DESCRIBED ABOVE UNDER YOUR STATE'S LAWS.

XM WX Satellite Radio Service Agreement

Hardware and required monthly subscription sold separately. Subscription fee is consumer only. Other fees and taxes, including a one-time activation fee may apply. All programming fees and weather data are subject to change. XM WX weather data displays and individual product availability vary by hardware equipment. Reception of the XM signal may vary depending on location. Subscriptions subject to Customer Agreement included with the XM Welcome Kit and available at xmradio.com and are available only in the 48 contiguous United States. XM WX is a trademark of XM WX Satellite Radio Inc.

Contact XM WX Satellite Radio by phone at (800) 985-9200 to subscribe to XM WX Weather.

This Page Intentionally Left Blank

Conventions

The following conventions, functionality, terminology, color philosophy, and definitions are used in this manual and on the EFD1000 PFD.

Covered Functionality

This guide covers all the functions available in the EFD1000 PFD and the optional Evolution Hazard Awareness that is only available with the Pro PFD model.

Some of the functions not available with the Pilot model are noted in the text as “Not available with the Pilot PFD”.

For the optional Evolution Synthetic Vision (ESV) functions, refer to the Aspen Avionics document 091-00031-001 [Evolution Synthetic Vision Pilot's Guide Supplement](#).

For complete instructions on the EFD1000 MFD and the EFD500 MFD, refer to the Aspen Avionics document number 091-00006-001 [EFD1000/500 MFD Pilot's Guide](#)

Terminology

The term “**PFD**”, is used throughout this Pilot's Guide and refers to the EFD1000 PFD.

Figure 1 shows a typical EFD1000 PFD display. This guide uses the terminology listed in **Table 1** when referring to specific parts of the PFD and **Chapter 4** provides an in-depth discussion and step-by-step instructions for all the available functionality.



Figure 1
EFD1000 PFD Display, Knobs, Buttons, and Keys

Term	Example
1	Buttons REV Button, Range Buttons, MENU Button
2	Hot Keys / Menu Keys Five keys on the lower right of the display
3	Buttons Lower Left Button, CDI Navigation Source Select Button, Lower Right Button
4	Knobs Left (CRS) Knob, Right (HDG) Knob
5	Navigation Display
6	Data Bar
7	Attitude Display

Table 1
EFD1000 PFD Display, Knobs, Buttons, and Keys

NOTE

As the number of colors used on the display is limited, to ensure adequate color differentiation under all lighting conditions, there are a few cases where a given color is used in a slightly different context than described in Table 2.

Color Philosophy

Table 2 provides the operational philosophy of color usage on the PFD display.

COLOR	PURPOSE	COLOR	PURPOSE
RED	Used to indicate flight envelope and system limits, and for warning annunciations that require immediate pilot recognition and which may require immediate pilot correction or compensatory action. Red is used to indicate Data Link Weather precipitation areas.	GREEN	Used for navigation information or mode data related to or provided by the navigation source currently selected for display on the Course Deviation Indicator (CDI) (i.e., navigation deviations, equipment operating state, waypoint information). Green is also used to indicate Data Link Weather precipitation areas and the status of user controls (i.e., ON, enabled, or active).
AMBER	Used to indicate abnormal information sources, and for caution information that requires immediate pilot awareness and for which subsequent pilot action may be required. Amber is used to indicate Data Link Weather precipitation areas.	WHITE	Used to show primary flight data (e.g., IAS, ALT, HDG), scales, and Menu items that are selectable for editing.
MAGENTA	Used for pilot-selectable references (bugs) enabled for editing, for depicting the active GPS navigation leg on a moving map display, and for depicting the flight director bar.	GRAY	Used to show supplemental flight data, and for Hot Key and Menu legends that are OFF, disabled, or inactive.
CYAN	Used to indicate editable values that are not currently selected for editing. CYAN is also used to display bearing pointers, proximity and other traffic icons, and GPS track marker.	BLUE	Used to indicate the sky and Data Link Weather precipitation areas.
		BROWN	Used to indicate the ground.

Table 2
Color Guide

Warnings, Cautions, and Notes

Where applicable warnings, cautions, and notes are given. Aspen Avionics uses the following icons and definitions (**Table 3**).



Icon	Definition
 Warning	Emphasizes a crucial operating or maintenance procedure, which, if not strictly observed, could result in injury to, or death of, personnel or long term health hazards. Indicates a hazard that may require immediate corrective action.
 Caution	Indicates an essential operating or maintenance procedure, which, if not strictly observed, could result in damage to, or destruction of, equipment. Indicates the possible need for future corrective action.
 Note	Highlights an important operating or maintenance procedure, condition, or statement. Safe operation.

Table 3
Warning, Caution, and Note

Example Graphics

The example graphics and screen shots used throughout this Pilot's Guide are provided for reference only and are taken from a simulated flight. They should not be used for actual flights.

Most of the example graphics and screen shots used throughout this Pilot's Guide & Reference are based on flying the ILS 16R instrument approach into Reno/Tahoe International Airport (KRNO) in Reno, Nevada, USA. Those images with the airplane in a right bank show the airplane completing the procedure turn in-bound to intercept the Localizer, descending through 8,660 feet to the target altitude of 8,500 feet. The other main group of images, showing the airplane straight and level, are earlier in the approach, tracking outbound for the procedure turn.

Pilot Familiarity

While the PFD is reasonably intuitive and easy to use, some familiarity with Electronic Flight Instrument Systems (EFIS) and Horizontal Situation Indicators (HSI) is required. Aspen Avionics strongly recommends that new users of the PFD get some dual instruction from an experienced instrument CFI, and spend some time becoming familiar with the PFD in day VFR conditions with a safety pilot, before flying in actual instrument meteorological conditions (IMC). To reduce pilot workload, the use of an autopilot (when available) is strongly encouraged.

Information Covered in this Pilot's Guide

This Pilot's Guide covers all the features and options available for an EFD1000 PFD. Because of individual configuration and options purchased, some features may not be available on your particular PFD.

Additionally, the Pilot PFD model does not offer the following features:

- Horizontal Situation Indicator (HSI)
- Dual Bearing Pointers
- Lateral and Vertical Deviation Indicators
- Minimums
- GPS and VLOC Navigation ARINC 429 Interface
- GPS Steering (GPSS)
- Optional Traffic
- Optional Lightning
- Optional Weather

NOTE

The Pilot PFD supports the display of flight plan and background navigation data from ARINC 429 GPS Interfaces.

NOTE

The Pilot PFD does not support the display of lateral or vertical deviations from an ARINC 429, or Analog GPS interface.

The Pilot PFD does not support the display of lateral or vertical deviations from an ARINC 429, or Analog VLOC interface.

Chapter 1

Welcome and Introduction

Welcome to Aspen Avionics' Evolution Flight Display (EFD) System, the most flexible, expandable, and upgradable Electronic Flight Instrument System (EFIS) available for general aviation aircraft. Designed to replace traditional mechanical primary flight instruments—in whole or in part, all at once, or in phases. This modularity and upgradability allows the system to grow with you and your airplane, over time and affordably.

The EFD system is built around the EFD1000 PFD, which replaces a vertical pair of your six primary flight instruments. The PFD has a bright, high-resolution, six-inch diagonal LCD display, and a number of knobs, buttons, and keys the pilot uses to control the system. The three-inch diameter, four-inch deep can on the back of the display slides into existing panel cutouts (where the top mechanical instrument used to be) (**Figure 1-1**).



Figure 1-1
EFD1000 Primary Flight Display Unit



Figure 1-2
Single Display EFD1000 PFD System



Figure 1-3
Dual Display System: PFD & MFD

The center of the EFD System is the EFD1000 Primary Flight Display (PFD), which replaces the traditional mechanical Attitude Indicator (AI) and Directional Gyro (DG) or Horizontal Situation Indicator (HSI) (**Figure 1-2**).

The PFD is available in two models—the EFD1000 Pilot and the EFD1000 Pro.

Add a second EFD1000 configured as a Multi-Function Display (MFD) (**Figure 1-3**), replacing the Altimeter and Vertical Speed Indicator (VSI), and you'll double the capabilities of your system, while also providing complete redundancy and backup to your PFD. The EFD1000 MFD contains the same AHRS, ADC, and I/O capabilities as the PFD for full redundancy and can assume the role of the PFD should it ever fail.

Adding another MFD, replacing the Airspeed Indicator (ASI) and Turn Coordinator, to round out a complete six-pack replacement and gain even more capability and flexibility (**Figure 1-4**). When you are ready to upgrade, simply contact an Aspen Avionics Authorized Dealer for more information.

This Pilot's Guide covers the EFD1000 Pilot model* and the EFD1000 Pro PFD model. These systems are powerfully flexible, and can be configured in a variety of ways, depending on the other aircraft systems with which they are integrated.

***The Pilot PFD model does not offer the following features:**

- Horizontal Situation Indicator (HSI)
- Dual Bearing Pointers
- Lateral and Vertical Deviation Indicators
- Minimums
- GPS and VLOC Navigation ARINC 429 Interface
- GPSS
- Optional Traffic
- Optional Lightning
- Optional Weather

NOTE

Please spend some time with your avionics installer to understand exactly how your PFD is installed and configured in your particular aircraft, to understand the features and capabilities available to you, and to understand how various aircraft system failures and abnormalities may affect your PFD.



Figure 1-4
Trio Display System: PFD & Dual MFDs

NOTE

With multiple EFD installations, an independent, standby attitude indicator must be within the pilot's primary maximum field of view.

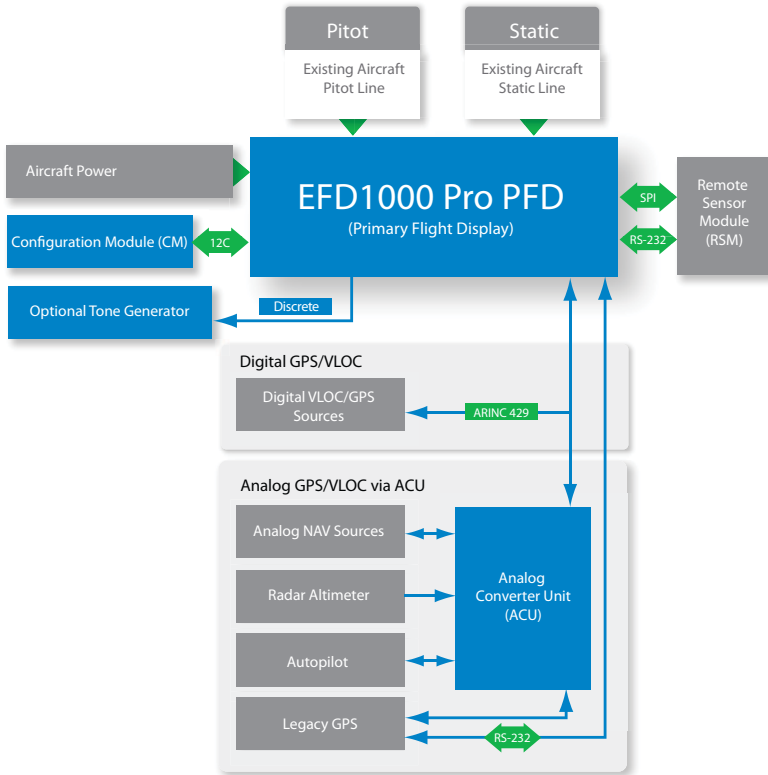

Figure 1-5
Pro PFD System Architecture

1.1. System Overview

The PFD system typically consists of four components:

1. EFD1000 Display Unit (PFD)
2. Configuration Module (CM)
3. Remote Sensor Module (RSM)
4. Analog Converter Unit (ACU)¹

The ACU converts older analog signals and interfaces to the industry-standard digital ARINC 429 interface, which is the native language of the PFD. In some installations, generally when the aircraft is not equipped with an autopilot and has only digital GPS/Nav/Comm, the ACU may be omitted.

The system architecture in **Figure 1-5** shows the relationships of the PFD, RSM, CM and ACU.

¹ Not available with the Pilot PFD

1.1.1. Primary Flight Display Unit (PFD)

The Primary Flight Display Unit (PFD) is a digital system that consists of a high resolution, six-inch diagonal color LCD display, user controls, photocell, and microSD data card slot. The three-inch diameter, four-inch deep can on the back of the display contains a non-removable electronics module that includes:

- A Sensor Board with solid-state Attitude and Heading Reference System (AHRS) and digital Air Data Computer (ADC)
- A Main Application Processor (MAP) board with Central Processing Unit (CPU), graphics processor and system memory
- An Input-Output Processor (IOP) board for integrating communications with other aircraft systems

Also on the rear of the unit (**Figure 1-6**) are:

- An access cover for removing and replacing the built-in backup battery
- Pneumatic connections to the aircraft's pitot and static systems
- 44-pin D-sub connector for electrical connections to the PFD
- A cooling fan, to cool the electronics and LCD backlights

The PFD mounts to the front surface of the instrument panel using the standard installation kit; an optional flush-mount installation kit is also available.

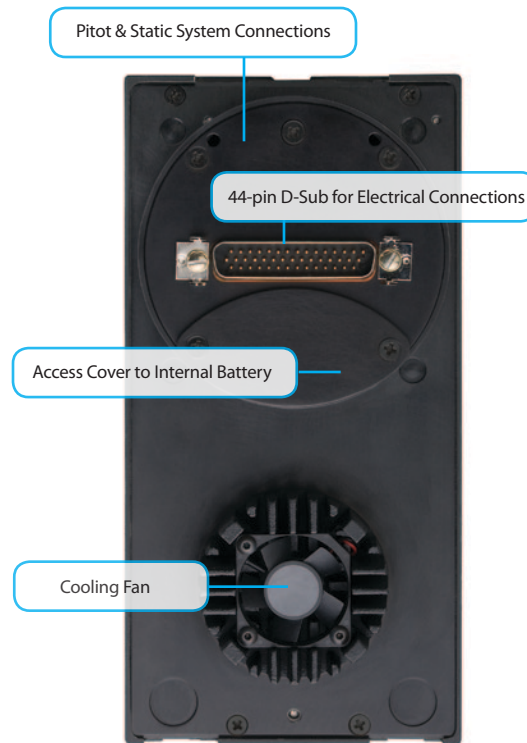

Figure 1-6
EFD1000 Display Unit
Rear Connections



Figure 1-7
Configuration Module (CM)

1.1.2. Configuration Module (CM)

The Configuration Module (**Figure 1-7**), contains an EEPROM device that retains system configuration and calibration data and provides two primary functions:

- Retains aircraft-specific configuration information, calibration data, and user settings, allowing the PFD to be swapped for service purposes without re-entering or re-calibrating the installation
- Contains a license key that configures the PFD software features

The CM is typically attached to the wire bundle coming out of the D-sub connector on the display unit.

1.1.3. Analog Converter Unit (ACU)¹

The Analog Converter Unit (ACU) (**Figure 1-8**), included with most Pro PFD systems, enables the all-digital, EFD1000 System to interface with analog avionics when required. The ACU converts multiple analog interfaces to the digital ARINC 429 buses supported by the PFD. Control parameters, such as desired heading, are also sent from the Pro PFD to the ACU for conversion to analog format for autopilot support. The ACU is required when any of the following capabilities are required in a Pro PFD installation:

- Interface to supported autopilots
- Interface to conventional VHF navigation radios
- Interface to legacy (non-ARINC 429) GPS navigators
- Interface to supported radar altimeter decision height annunciations

If ARINC 429-based digital radios, such as the Garmin 400/500-series GPS/nav/comm radios are installed in the aircraft and no other aircraft interfaces are desired, the ACU is not required.



Figure 1-8
Analog Converter Unit (ACU)

1. Not available with the Pilot PFD

1.1.4. Remote Sensor Module (RSM)

The Remote Sensor Module (RSM) (**Figure 1-9**), is an integral part of the EFD1000 system and works together with the display unit sensors as part of the AHRS and ADC. The RSM looks and mounts like a GPS antenna and is mounted on the exterior of the fuselage, typically aft of the cabin.

The RSM contains the following sub-systems:

- 3D magnetic flux (heading) sensors
- Outside Air Temperature (OAT) sensor
- Emergency backup GPS engine and antenna

The RSM communicates with the PFD via a digital cable connection.



Figure 1-9
Remote Sensor Module (RSM)

1.1.5. Evolution Weather Receiver (EWR50)¹

The optional Evolution Weather Receiver, EWR50 (**Figure 1-10**) converts the XM WX Satellite Weather data into a digital format displayed on the EFD1000 Pro PFD. The EWR50 provides the ability to receive XM WX Satellite Weather data with a paid subscription to XM WX Satellite Weather service. The EWR50 consists of a receiver and antenna.



Figure 1-10
Evolution Weather Receiver (EWR50) - Optional

NOTE

A single EWR50 Receiver will supply data to all EFD units installed on the aircraft.

1. Not available with the Pilot PFD

 **NOTE**

The PFD only requires a preloaded microSD card to support the Evolution Synthetic Vision (ESV) option when installed. Otherwise, the PFD does not require a microSD card.

 **NOTE**

When configured with the ESV option, refer to the Evolution Synthetic Vision Pilot's Guide Supplement, 091-00031-001.

1.1.6. Evolution Databases

The Evolution Flight Display System includes two separate databases loaded on a microSD card; one from Jeppesen and one from Seattle Avionics Software.

- The Jeppesen database consists of NavData®, Obstacle, Cultural, and Terrain data.
- The Seattle Avionics database features Instrument Approach Procedure (IAP) charts, Departure charts, Standard Terminal Arrival Route (STAR) charts, and airport diagrams.

Refer to **Chapter 7 Appendices**, for additional information and instructions about updating the databases onto the microSD card.

 **NOTE**

For aircraft with an EFD1000 PFD only and the Evolution Synthetic Vision (ESV) option installed:

Only the Jeppesen database is required to be loaded on the microSD card.

 **NOTE**

For aircraft configured with multiple EFDs; PFD and MFD(s):

The MFD requires both databases loaded on the microSD card; the Jeppesen database for all mapping functions and the Seattle Avionics database for displaying chart data.

Whenever the Evolution Synthetic Vision (ESV) option is installed, the preloaded microSD card is compatible with either the PFD or the MFD and may be interchanged

Chapter 2

Controls and Display

The PFD is a flat-panel LCD primary flight instrument that presents the pilot with all of the information from the traditional six-pack of mechanical instruments: Airspeed, Attitude, Altitude, Turn Coordinator, Heading Indicator (or HSI) and Vertical Speed Indicator (VSI). Modern technology and standard EFIS symbology enable the consolidation of all six instruments into a single display, tightening the pilot's instrument scan and reducing pilot workload.

The PFD is a single vertical instrument that replaces the existing Attitude Indicator and Heading Indicator/HSI. The display is divided into three parts: an upper Attitude Display, a lower Navigation Display, and a Data Bar between the upper and lower halves. The Attitude and Navigation displays are highly customizable — from stripped-down, minimalist presentations, to dense, information-rich displays — depending on pilot preference and phase of flight.

This chapter gives an overview of all the instruments, information, and controls of the PFD. **Table 2-1** and **Figure 2-2** identify the controls and display orientation (see **Chapter 4, Reference Guide** for more details).



Figure 2-1
Pilot PFD



Figure 2-1a
Pro PFD

2.1. Controls & Display Orientation

CONTROLS		ATTITUDE DISPLAY	
1	Reversion and Power Button	16	Attitude Display
2	Range Buttons	17	Aircraft Reference Symbol
3	Menu Button	18	Single-Cue Flight Director ^{2,4}
4	1/2 Hot Key Menu 1 of 2 ⁴	19	Roll Pointer
5	MIN - Minimums ⁴ On/Off	20	Slip/Skid Indicator
6	360/ARC View	21	Altitude Tape
7	GPSS - GPS Steering ⁴ On/Off	22	Selected Altitude Field (controls the Altitude Bug)
8	BARO	23	Altitude Alerter
9	Right Knob	24	Numerical Altitude Indication, Altitude Drum/ Pointer
10	Lower Right Button, Double-Line Bearing Pointer Source Select ⁴	25	Altitude Trend Vector
11	CDI Navigation Source Select Button ⁴	26	Altitude Bug
12	Lower Left Button, Single-Line Bearing Pointer Source Select ⁴	27	Decision Height Annunciation ^{3,4}
13	Left Knob	28	Selected Minimums Field ⁴
14	Automatic Dimming Photocell	29	Radio Altitude ^{3,4}
15	microSD Card Slot	30	MINIMUMS Marker ⁴
		31	LDI Navigation Source Annunciation ⁴
		32	Airspeed Tape
		33	Selected Airspeed Field (controls the Airspeed Bug)
		34	Airspeed Bug
		35	Numerical Airspeed Indicator, Airspeed Drum/ Pointer
		36	Vertical Deviation Indicator (VDI) ⁴
		37	Lateral Deviation Indicator (LDI) ⁴

DATA BAR		57	Vertical Speed Tape
38	True Airspeed (TAS) or Mach number	58	Single-Line Bearing Pointer ⁴
39	Barometric Pressure Setting Field	59	Single-Line Bearing Pointer Source ⁴
40	Wind Direction and Speed	60	Single-Line Bearing Pointer Source Info Block ⁴
41	Wind Direction Arrow	61	Double-Line Bearing Pointer ⁴
42	Outside Air Temperature (OAT)	62	Double-Line Bearing Pointer Source ⁴
43	Ground Speed	63	Double-Line Bearing Pointer Source Info Block ⁴
NAVIGATION DISPLAY		64	Selected CDI Navigation Source ⁴
44	Navigation Display	65	Selected CDI Navigation Source Information Block ⁴
45	Ownship Symbol	66	Left Knob State
46	Course Pointer ⁴	67	Right Knob State
47	TO/FROM Indicator ⁴	68	Hot Key Label
48	Rate of Turn Indicator	69	Basemap Range
49	Ground Track Marker	70	Declutter Level

Table 2-1
PFD Components

1. The Hot Key menu 2/2 is only available when the Pro PFD is configured with the optional Evolution Hazard Awareness option and the associated sensor(s)
2. With compatible autopilots
3. With compatible radar altimeters
4. Not available with the Pilot PFD
5. When configured with the Evolution Synthetic Vision option, refer to the Evolution Synthetic Vision Pilot Guide Supplement 091-00031-001 for additional Hot Key menu

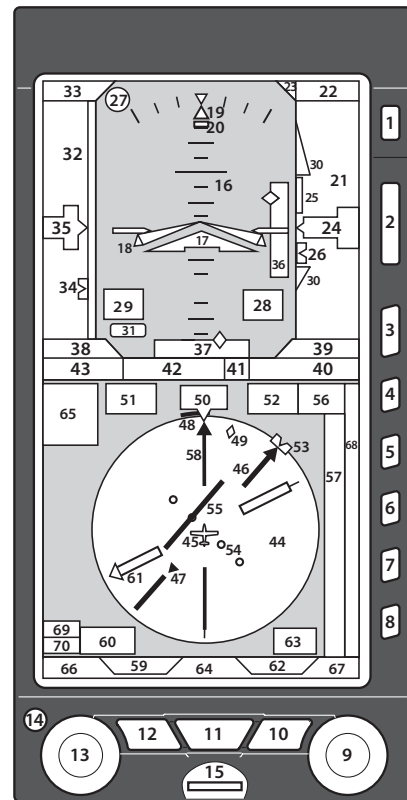

Figure 2-2
Pro PFD Display Elements

2.2. Controls

The primary means for the pilot to control the PFD are the two knobs and three buttons at the bottom of the display. The knobs control setting CRS and HDG, and additional bugs and altitude settings. The lower three buttons control selection of navigation sources for the CDI and Bearing Pointers. There are three additional buttons above the Hot Keys to control entering and exiting the Menu, setting the Map Range, and Reversion or Manual Power Control.

Five Hot Keys to the right of the Navigation Display toggle various features on and off. The function of each is indicated by the label on the display to the left of each key.

2.2.1. Left and Right Knobs

The Left and Right Knobs are designed to provide immediate operation yet minimize the possibility of an inadvertent operation. This is accomplished by requiring that the first action of the knob “wakes up” the knob and changes the label from cyan to magenta. The first click when the knob is turned or the first press on the knob, “wakes up” the knob function.

Press the knob more than once to cycle through its Menu options in a round-robin sequence or press and hold the knob to synchronize (SYNC) the function's value (**see Section 2.2.1.3. SYNC Function**). After 10 seconds of inactivity, the knob returns to its default setting.

 **NOTE**

The Pilot PFD Navigation Display has a slaved Directional Gyro instead of an HSI. It does not have a Course Pointer, Course Deviation Indicator, or Bearing Pointers.

The Pilot PFD also does not include an approach minimums (MIN) setting. Therefore, these knob functions are not available on the Pilot PFD.

2.2.1.1. Left Knob Functions

The Left Knob is used to set the Course (CRS) and Airspeed Bug (IAS). Course (CRS) is the default setting for the Left Knob.

Refer to **Table 2-1** and **Figure 2-2**

- Rotate the Left Knob one click or Press the knob once to set the course (CRS) (**Refs. 46 and 51** and see **NOTE** about Auto Course)
- Press the Left Knob twice to set the Airspeed Bug (IAS) and Selected Airspeed Field (**Refs. 33 and 34**)

2.2.1.2. Right Knob Functions

The Right Knob is used to set Heading (HDG), Selected Altitude Field (ALT), Barometric Pressure (BARO), and Instrument Approach Minimums (MIN)¹. Successive presses of the Right Knob will cycle through HDG and ALT (and MIN¹, if selected) in a round-robin sequence. Rotate the Right Knob to the left or right to decrease or increase the value of selected field. Heading (HDG) is the default setting for the Right Knob.

Refer to **Table 2-1** and **Figure 2-2**

- Rotate the Right Knob one click or Press the knob once to set the Selected Heading Field/Heading Bug (HDG) (**Refs. 52 and 53**)
- Press the Right Knob twice to set the Selected Altitude Field (ALT)/Altitude Bug (**Refs. 22 and 26**)
- When the MIN Hot Key is selected¹, press the Right Knob three times to set the Selected Minimums Field (MIN) (**Ref. 28**)

NOTE¹

*MIN will only be shown if the MIN function is already active. When the MIN function is active, the MIN Hot Key label (**Ref. 5**) is shown in green with dark blue letters, and the MIN value is shown on the Attitude Display (**Ref. 28**).*

When the MIN function is inactive (blue label with green letters), pressing the MIN Hot Key will both activate the function and immediately make it available for editing.

NOTE

*When the CDI navigation source is selected to a GPS receiver and the Auto Course is enabled in the Menu, the course is set automatically by the GPS and is not pilot-adjustable (see **Section 4.4.6**). This state is indicated by the CRS field and Knob label shown in green with an inverse "A". In this case, pressing the Left Knob will enable you to set only the Airspeed Bug (IAS).*

1. Not available with the Pilot PFD



Figure 2-3
Left and Right Knobs and Corresponding Fields

2.2.1.3. SYNC Function

Knob SYNC Function

1. Press the Knob until its state shows the value you want to set in magenta.
2. Press and hold the Knob for approximately one (1) second to SYNC the field's value according to the rules shown in **Table 2-2**.
3. After 10 seconds of inaction, the knob reverts to its home state (CRS or HDG), and the labels and field turn to cyan (inactive).

Right Knob		
	SYNC Action	
1	ALT	Altitude Bug and Altitude Alerter are set to the current altitude.
2	MIN	Set to the current altitude.
3	BARO	Set to 29.92 in Hg or 1013 mB.
4	HDG	Set to the current heading.
5	Right Knob -Current State default setting: HDG Cyan indicates field is inactive.	

Left Knob			
	SYNC Action		
6	IAS	Set to the current indicated airspeed.	
7	CRS	VOR navigation	Course Pointer points to the VOR. CRS value is the reciprocal of the current VOR radial. The deviation bar centers with a "TO" indication.
		ILS navigation	Current aircraft heading.
		GPS	Course Pointer points to the active GPS waypoint. The deviation bar centers with a "TO" indication. (AUTO CRS must be disabled).
		GPS AUTO CRS enabled	No effect.
8	Left Knob - Current State default setting: CRS Cyan indicates field is inactive.		

Table 2-2
Left and Right Knob SYNC Description



Figure 2-5
Editing the HDG field



Figure 2-6
HDG field updated and inactive

2.2.1.4. Using the Knobs (Example)

How to Set the Heading Bug (HDG)

1. Rotate the Right Knob to the desired heading value, shown both by the position of the Heading Bug and the numeric value in the Selected Heading Field (Figure 2-5). The HDG label, Heading Bug and the Selected Heading Field appears in magenta
2. After 10 seconds of inactivity, the knob defaults to HDG. The HDG label, Heading Bug and Selected Heading Field value will appear in cyan (Figure 2-6).

2.2.2. Navigation Source Select Buttons¹

The three buttons on the bottom of the PFD (Figure 2-7) allow the pilot to select the navigation source for the CDI and Bearing Pointers (see [Section 4.4.5. CDI Navigation Source](#) and [Section 4.4.8. Bearing Pointer Source Selection](#) for more detailed information).

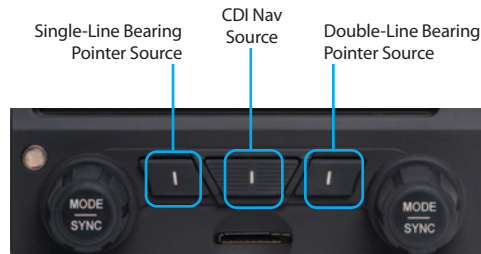

Figure 2-7
CDI and Bearing Pointer Source Select Buttons

¹ Not available with the Pilot PFD

2.2.2.1. CDI Navigation Source Select Button¹

The CDI Nav Source Select Button is the center button (Figure 2-7). It selects which of the available navigation sources will couple to the CDI, which in turn couples to the autopilot (if available). Each press of the CDI Nav Source Button selects the next available nav source, cycling through all available sources in a round-robin sequence. The currently coupled CDI nav source is displayed directly above the CDI Nav Source Select Button.

The available navigation sources are configured when the PFD was installed (depending on what is installed in the aircraft and connected to the PFD). The available navigation source choices are: GPS1, GPS2, VLOC1, and VLOC2.

If a navigation source is configured to be available, but is not providing valid navigation data, its navigation source annunciation will be shown with a red slash through it, and the CDI will not be shown with the Course Pointer. The pilot is able to select the invalid source, but no navigation data is provided.

When one or more of the connected navigation sources is a combined GPS/Nav device (e.g., some of the Garmin 400/500-series), the list of navigation sources available for selection will be determined by the current CDI mode of the GPS navigator.

NOTE

The Pilot PFD does not display any CDI or Bearing Pointers. Its center CDI Nav Source Select Button is used only to select which connected GPS source (GPS1 or GPS2) is used to display the GPS flight plan, waypoints, and basemap symbols.

NOTE

When GPS is selected as the CDI's nav source, but no active waypoint is programmed in the GPS navigator, that source will be shown as invalid until an active flight plan or direct-to waypoint is programmed into the GPS.

For example, with a Garmin GNS-430 installed as the #1 navigation source, when "GPS" is shown immediately above the CDI Button on the GNS-430, the PFD will show GPS1 as an available, but invalid, nav source. When the pilot presses the CDI Button on the GNS-430 so that VLOC is now displayed on the GNS-430, the PFD will show VLOC1 as the available nav source, and GPS1 cannot be selected.

1. Not available with the Pilot PFD

2.2.2.2. Bearing Pointer Source Select Buttons¹

The Lower Left Button and the Lower Right Button are the Bearing Pointer Nav Source Select Buttons (**Figure 2-7**). The Lower Left Button controls the Single-Line Bearing Pointer and the Lower Right Button controls the Double-Line Bearing Pointer. Each button controls which nav source is connected to the respective Bearing Pointer.

The Bearing Pointers act like a conventional RMI (Radio Magnetic Indicator); the needle points to the station. Unlike a conventional RMI, the PFD Bearing Pointers can also point to the active waypoint of a GPS navigator whether that is a VOR, NDB, airport, intersection, or missed approach point.

Each Bearing Pointer can be connected to any of the available navigation sources; GPS1, VOR1, GPS2, VOR2, ADF1 or ADF2 (depending on configuration), or to none. Each press of the Bearing Pointer Nav Source Select Button selects the next available nav source, cycling through all available nav sources and none, in a round-robin sequence. The currently connected nav source is displayed directly above its respective button; blank with only the Bearing Pointer icon indicates that no nav source is selected, and the Bearing Pointer is removed from the display.

If the selected nav source is a valid choice, but no usable nav data is being received (e.g., the VOR station is out of range, or the VLOC is tuned to a localizer frequency), the Bearing Pointer will not be displayed.

1. Not available with the Pilot PFD

2.2.3. Hot Keys

The five Buttons along the lower right side of the PFD function as either single-action Hot Keys for frequently used commands or as Menu Keys when the Menu has been activated. The Hot Key functions are accessible at any time, except when the Menu is active.

Each Hot Key provides instant access to the assigned command. Each press of a Hot Key toggles between the settings that each key controls (see **Table 2-3**).

The Hot Key labels use the following color philosophy (see **Figure 2-8** and **Figure 2-9**).

- A green label and dark blue letters (also known as inverse green) indicates that the Hot Key function is enabled
- A dark blue label and green letters indicates that the Hot Key function is disabled
- A dark blue label and gray letters indicates that the Hot Key function is not available
- A dark blue label without letters indicates that the Hot Key has no function

The 360/ARC Hot Key labels indicate which mode is currently active on the Navigation Display.

NOTE¹

*When configured with the Evolution Hazard Awareness option, there are two levels of Hot Keys controlled by the first Hot Key (1/2 or 2/2). The second level (2/2) provides access to Hazard Awareness overlays as described in **Chapter 4, Section 4.8. Hazard Awareness**.*

NOTE

The TRFC Filter Hot Key is blank when Traffic Software Option is not installed.

1. Not available with the Pilot PFD

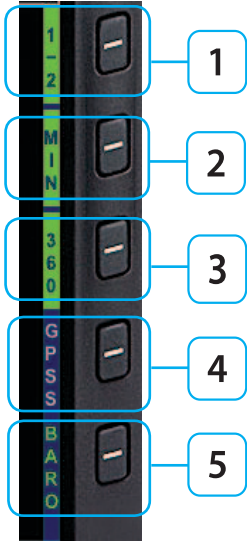

Figure 2-8
Hot Key Menu 1 of 2

HOT KEY		DESCRIPTION	OPTIONS	
1	1/2 ¹	Hot Key Menu selection	1/2	Hot Key Menu 1 of 2
			2/2	Hot Key Menu 2 of 2 ⁵
2	MIN ¹	Enables and displays, or disables and hides, Minimums Alerter ^{1,2} (see Section 4.2.3.4 .)	MIN	Minimums displayed and Altitude Alerter enabled ²
			MIN	Minimums alerter disabled
3	360 / ARC	Toggles between 360 and ARC modes of Navigation Display (see Section 4.4.1 .)	360	ARC Compass Mode
			ARC	360° Compass Mode
4	GPSS ^{1,3,4}	Toggles between GPS Steering (GPSS) Mode and HDG mode for Autopilot/Flight Director ⁴ (see Section 4.7.1 .)	GPSS	GPSS on
			GPSS	GPSS Off, HDG mode active
5	BARO	Toggles between BARO adjustment on or off for Barometric Pressure setting	BARO	BARO adjustment on
			BARO	BARO adjustment off

HOT KEY	DESCRIPTION	OPTIONS		
6	2/2 ^{1,5}	Hot Key Menu selection	2/2	Hot Key Menu 2 of 2
			1/2	Hot Key Menu 1 of 2
7	LTNG ^{1,5}	Toggles between Lightning Overlay options (see Section 4.8.1.)	LTNG	Data Link Lightning Overlay on
			STRK	WX-500 Strike Overlay on
			CELL	WX-500 Cell Overlay on
			LTNG	All Lightning off
8	NXRD ^{1,5}	Displays Data Link Weather and Radar Coverage overlay (see Section 4.8.2.)	NXRD	NEXRAD Overlay on
			NXRD	NEXRAD Overlay off
9	TRFC ^{1,6}	Displays Traffic overlay (see Section 4.8.3.)	TFCN	Normal Filter
			TFCU	Unrestricted (No Filtering)
			TFCA	Above Filter
			TFCB	Below Filter
			TRFC	Traffic Overlay off
10	BARO ¹	Toggles between BARO adjustment on or off for Barometric Pressure setting	BARO	BARO adjustment on
			BARO	BARO adjustment off

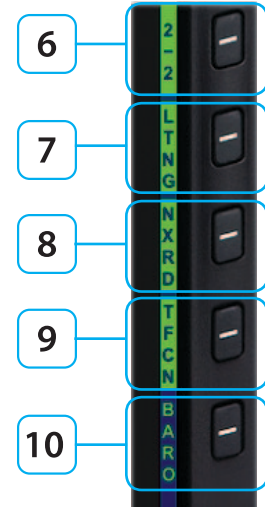

Figure 2-9
Hot Key Menu 2 of 2

Table 2-3
Hot Key Descriptions

1. Not available with the Pilot PFD
2. When the Minimums field is first enabled with the MIN Hot Key, the MIN value is immediately available for editing
3. Flight plan legs and waypoints display available in all installations including a GPS navigator. Basemap display of nearby waypoints available with all ARINC 429 GPS navigators and some RS-232 GPS navigators
4. GPSS available only with ARINC 429-based navigators
5. Hazard awareness overlays are available only on the Pro PFD with the Evolution Hazard Awareness (EHA) option and compatible hazard awareness sensors are installed and configured to the Pro PFD. The Hot Key label is blank when function is not available
6. The Traffic Filter Hot Key label is blank when the Traffic overlay function is not available



Figure 2-15
Menu Navigation Mode

2.2.4. Menu

The MENU button is used to access the EFD1000 PFD's Menu to change options, and also to change the PFD's display brightness.

2.2.4.1. Using the Menus

Press the MENU button to activate the Menu (**Ref. 3**). The current menu page name is shown on the bottom center of the Navigation Display. Directly below the menu page name is a segmented menu page bar, giving a graphical representation of the current page relative to the total number of menu pages. The current menu page number is shown in the lower right corner of the Navigation Display.

Menu Page 1, General Settings A, is the one most commonly used in flight. It allows the pilot to enable or disable the AUTO COURSE SELECT mode, to display or hide the Vs speeds on the airspeed tape, and to choose CDI type for the ARC Compass mode. The other menu pages are used for barometric pressure and Outside Air Temperature (OAT) units of measure settings, Auto Range, Vs speeds and map customization, PFD power management, product version information, and information and option settings, relative to your specific equipment and installed options.

The Menu operates either in the Navigation or Edit mode, as indicated by the label directly above the Right Knob. When the MENU button is first pressed, the Main Menu is in the Navigation mode, indicated by the magenta label SEL PAGE directly above the Right Knob (**Figure 2-15**). When in the Navigation mode, rotating the Right Knob navigates through the menu pages. Rotate the Right Knob clockwise to advance to the next menu page, counterclockwise to return to the previous page.

Each Menu Page has up to five selectable options, each adjacent to one of the five Hot Keys which double as Menu Keys when the Menu is active (**Item 1 of Figure 2-17** and **Table 2-4**). After navigating to the Menu Page containing the option you want to change, press the Menu Key adjacent to that option label, which initiates the Menu's Edit mode. When the Menu is in the Edit mode, the label, EDIT VALUE, is shown above the Right Knob in magenta (**Figure 2-16**), and the label of the item selected for editing is also shown in magenta. Rotate the Right Knob to change the value of the selected item. When finished, either select another displayed Menu option to change, or press the Right Knob to exit the Edit mode and return to Navigation mode to select another Menu Page.



Figure 2-16
Menu Edit Mode

When you are finished changing Menu options, press the MENU Button to exit.

- 1** Menu Options
- 2** Menu Page number and mode (Navigation mode shown)
- 3** Menu Page Name
- 4** Menu Page graphical bar
- 5** Brightness Control (see **Section 2.2.4.2.**)

Table 2-4
Menu

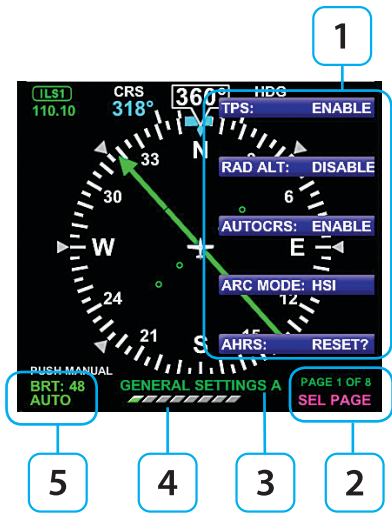

Figure 2-17
Main Menu

TPS: ENABLE

Figure 2-18
Menu Text - Editable

TPS: ENABLE

Figure 2-19
Menu Text - Enabled for Editing

US NXRD AGE: 16

Figure 2-20
Menu Text - Status Only

Vle: 129

Figure 2-21
Menu Text - Disabled



Figure 2-22
Menu Display

The MENU text will display in one of the four colors listed and described in **Table 2-5**.

DISPLAY TEXT	DESCRIPTION	DISPLAY
WHITE	Editable option	Figure 2-18
MAGENTA	Editable option enabled	Figure 2-19
GREEN	Status Only	Figure 2-20
GRAY	Disabled (Not available for selection or editing)	Figure 2-21

Table 2-4
Menu Text

NOTE

These steps are provided as a basic overview. Each menu command is covered in detail in Chapter 5.

Access To and Navigation Within the Menu

1. Press the MENU button. The Menu displays on the Navigation Display adjacent to the Hot Keys (**Figure 2-22**).
2. Rotate the Right Knob to navigate through the different pages of the Menu. Rotating the Right Knob clockwise advances the Menu Pages, counterclockwise returns to previous pages.
3. Press the MENU Button to exit.

Edit Main Menu Items

1. Press the MENU Button.
2. Navigate to the desired Menu Page.
3. Press the Menu Key of the desired option. The Menu label turns magenta, and the EDIT VALUE label displays above the Right Knob (**Figure 2-23**).
4. Rotate the Right Knob to the desired value.
5. Press the Right Knob to return to Menu navigation mode.
6. Press the MENU Button to exit.

NOTE

Pressing the Right Knob returns to Navigation mode and allows selection of other menu options on different pages. Pressing another menu key on the current menu page saves any changes made and activates the newly selected option for editing.



Figure 2-23
EDIT VALUE Displays Above Right Knob

NOTE

Upon reaching the end of a list of editable menu options, continued rotation of the knob will not result in the continuous wrapping through the available editable menu options. Spinning the knob fully clockwise will go to the last menu page, while spinning the knob fully counterclockwise will go to the first menu page.



Figure 2-24
Display Brightness in BRT AUTO Mode



Figure 2-25
Display Brightness in BRT ADJUST Mode

2.2.4.2. Display Lighting

When the MENU button is pressed and the Menu is active, the Left Knob can be used to adjust the PFD display brightness.

By default, the LCD brightness operates in AUTO mode, and is adjusted based on photocell sensing of ambient lighting conditions. When the MENU is active and the LCD is in the BRT AUTO mode, the word, "AUTO", and a brightness level of 1-100 will be displayed in green above the Left Knob (**Figure 2-24**).

To override the AUTO brightness setting, press the Left Knob once to switch to the BRT ADJUST mode, and then rotate the Left Knob to set the brightness to the desired level (**Figure 2-25**). To return to AUTO brightness control, press the Left Knob again.

LCD MODE	DESCRIPTION	DISPLAY
Automatic BRT AUTO	LCD backlight intensity is automatically adjusted based on the ambient lighting conditions sensed by the Automatic Dimming Photocell. The maximum intensity in AUTO mode is 70%.	Figure 2-24
Manual BRT ADJUST	Allows the pilot to adjust the PFD display brightness from 1-100%	Figure 2-25

Table 2-5
Brightness Control

NOTE

The BRT AUTO display brightness level is determined by the amount of light detected by the photocell on the front of the PFD. If a light is used to illuminate the instrument panel, the photocell will respond, resulting in a bright display. When this happens, use the manual BRT ADJUST mode to reduce the brightness.

2.2.5. Range Buttons

When the MAP is enabled, the RNG (Range) Button is used to zoom the map in or out. Press the RNG (+) Button to increase map range. Press the RNG (-) Button to decrease map range. Additionally, an Auto Range control feature is available.

Pressing and holding either the RNG (+) or (-) Button will cause the map range to scale continuously to its maximum or minimum range, respectively. When the map range is at its maximum or minimum setting, release and then press and hold the RNG Button again to activate the Auto Range control mode (see **Section 4.4.12.1.** for more details).

2.2.6. REV Button

The red REV Button on the PFD can be used to override automatic power control in abnormal or emergency situations (see **Chapter 6, Section 6.4.** and **Figure 6-29** for more details).



Figure 2-26
PFD Display Areas

2.3. Display

The PFD replaces the existing Attitude Indicator and HSI or DG in the center of the primary flight instrument cluster. Like the instruments it replaces, the top half presents an Attitude Display and the bottom half contains a Navigation Display (**Figure 2-26**). Between the two halves is the Data Bar. The Data Bar contains a dedicated display of real-time winds, Outside Air Temperature (OAT), True Airspeed (TAS), and GPS Ground Speed (GS).

- 1 Attitude Display
- 2 Data Bar
- 3 Navigation Display

Unlike the mechanical indicators it typically replaces, PFD can also display all the data provided by the remaining four instruments in the six pack (airspeed, altitude, turn and slip, and vertical speed), and much more. Concentrating all primary flight information onto a single instrument directly in front of the pilot improves instrument scan and reduces pilot workload, thereby enhancing safety, especially in busy phases of flight. Additionally, analog backup instruments can be retained in the pilot's primary field of view, and should be included in the instrument scan to cross-check indications of both the primary (EFIS) and backup (analog) instruments.

The PFD generally follows standard display conventions for Electronic Flight Instrument Systems (EFIS), so a pilot with some experience and familiarity with other EFIS PFDs will usually transition quickly to using the EFD1000. Pilots for whom the EFD1000 PFD is their first real exposure to EFIS and glass cockpit flying, however, should get some transition training from a certified instrument flight instructor (CFII) with EFIS experience. Pilots are also encouraged to study some of the excellent publications and training videos now available to help with the transition.

This section gives an overview of the main display elements and features. (see **Chapter 4, Reference Guide** for more details).

2.3.1. Cleaning the Display Screen

The PFD Display Unit has an LCD screen that is prone to damage from scratches, smudging, and clouding caused by the use of improper cleaning agents and abrasive cloths. Exercise care when cleaning, using the following tips:

- Only clean the display when the PFD is off.
- Use a clean, soft, lint-free cloth dampened with a 50/50 solution of isopropyl alcohol and water, a pre-moistened lens cleaning tissue, such as Bausch & Lomb Sight Savers®, or a cleaning solution made especially for LCD displays.
- Never spray any cleaning solutions directly onto the screen; spray it into the cleaning cloth.
- Gently wipe the screen in a circular motion. Do not press hard on the screen.
- Remove all excess moisture to prevent damage to the display.
- The display should be dry before turning on the PFD.



CAUTION

Use caution when using isopropyl alcohol as it is flammable. Using any other chemicals or materials voids the warranty.

2.3.2. Attitude Display

The Attitude Display includes an Attitude Director Indicator (ADI) with a single-cue Flight Director command V-bars (when connected to a compatible autopilot), an Airspeed tape, an Altimeter tape, an Altitude Alerter, Radio Altitude, approach minimums annunciations, and approach course and glide slope indicators (**Table 2-7** and **Figure 2-27**), (see **Chapter 4, Reference Guide** for more details).

The Airspeed and Altitude tapes are the most obvious differences from a mechanical ADI. These tapes are common on most EFIS PFDs and will be immediately familiar to pilots with EFIS experience. Pilots without prior EFIS experience may need some training and experience to become to get comfortable with the Airspeed and Altimeter tapes as their primary references.

In single-display PFD installations, where the mechanical airspeed indicator and altimeter remain in their original locations, transitioning pilots can use either their familiar mechanical instruments or the PFD tapes for airspeed and altitude references. Many pilots new to EFIS quickly find themselves relying on the tapes within a flight or two. Should the tapes prove distracting, the pilot can remove them from the display by disabling them in the Menu. (Page 1, GENERAL SETTINGS A — single display installations only).

ATTITUDE DISPLAY			
16	Attitude Display	27	Decision Height Annunciation ^{2,3}
17	Aircraft Reference Symbol	28	Selected Minimums Field ²
18	Single-Cue Flight Director ^{1,2}	29	Radio Altitude ^{2,3}
19	Roll Pointer	30	MINIMUMS Marker ²
20	Slip/Skid Indicator	31	LDI Navigation Source Annunciation ²
21	Altitude Tape	32	Airspeed Tape
22	Selected Altitude Field	33	Selected Airspeed Field
23	Altitude Alerter	34	Airspeed Bug
24	Numerical Altitude Value, Altitude Drum/Pointer	35	Numerical Airspeed Value, Airspeed Drum/Pointer
25	Altitude Trend Vector	36	Vertical Deviation Indicator (VDI) ²
26	Altitude Bug	37	Lateral Deviation Indicator (LDI) ²

Table 2-6
Attitude Display Components

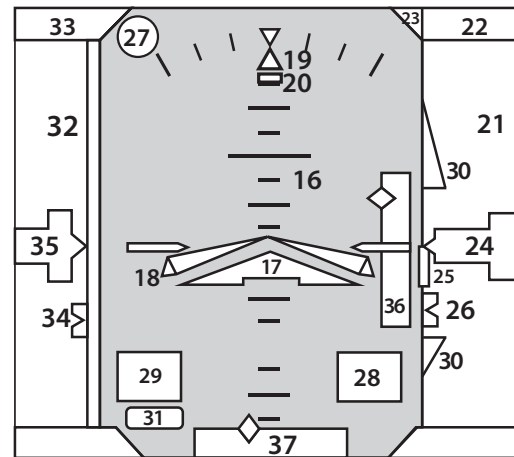

Figure 2-27
Attitude Display Components

1. With compatible autopilots
2. Not available with the Pilot PFD
3. With compatible radar altimeters



Figure 2-28
Slip/Skid

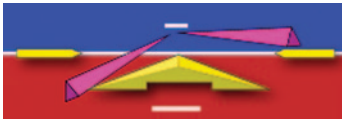

Figure 2-29
Flight Director

2.3.2.1. Attitude Director Indicator (ADI)

The Attitude Director Indicator (ADI) features a conventional blue (sky) over brown (ground) background, with a white horizon line dividing the two areas. A triangular Aircraft Reference Symbol (**Ref. 17**) is in a fixed position and shows aircraft attitude relative to the horizon.

The pitch scale (or ladder) indicates degrees of nose up (blue) or nose down (brown) pitch relative to the apex of the aircraft symbol. Minor pitch marks are shown every 2.5° up to +/-20° of pitch, with major pitch marks every 10° up to +/-90° of pitch. The distance between pitch marks is greater than on most mechanical attitude indicators, making it easier for the pilot to fly more precise pitch attitudes.

At extreme pitch attitudes (above 30° nose up or below 25° nose down), red Unusual Attitude Recovery chevrons come into view, pointing towards the horizon or ground as applicable (see **Chapter 4, Section 4.2.1.2. Pitch Scale**). At extreme pitch attitudes, some sky (blue) or ground (brown) will always be displayed to help maintain situational awareness, even though the horizon line may be off-scale.

At the top of the ADI are the roll scale, roll pointer, and slip/skid indicator (**Figure 2-28**). The roll scale is indicated by tick marks at 10°, 20°, 30°, 45°, and 60° on both sides of the zero roll inverted solid white triangle. The 45° marks are represented as hollow triangles.

Slip/skid is indicated by the lateral position of the white rectangle under the roll pointer. One rectangle width is equivalent to one ball width of a conventional inclinometer.

When connected to a compatible autopilot system, the PFD will display a single-cue Flight Director (FD) (**Figure 2-29**). The Flight Director command bars visually represent the lateral and vertical steering cues transmitted to the PFD by the autopilot. When the FD output from the autopilot is unavailable or invalid, the FD command bars are removed from the display.

2.3.2.2. Airspeed Tape and Bug

Airspeed is indicated by a moving airspeed tape against a fixed position airspeed pointer, shown on the left-hand side of the Attitude Display (**Figure 2-30**). A numerical, rolling drum readout indicating airspeed values to the closest one knot or mile per hour is provided adjacent to the fixed pointer. Tick marks are provided on the airspeed tape every 10 knots (or mph, if so configured). Airspeeds between 20 kts (23 mph) to 450 kts (518 mph) are displayed. Outside of this range, the airspeed value is dashed.

Color speed bands are displayed on the indicated airspeed tape, corresponding to the color arcs found on a mechanical airspeed indicator.

Color speed markers are also displayed on the indicated airspeed tape, corresponding to the markers found on traditional airspeed indicators. All aircraft have a red line for aircraft never-exceed speed (V_{ne}). Multi-engine aircraft will usually also have another red line for single-engine minimum control speed (V_{mc}), and a blue line for single-engine best rate of climb speed (V_{yse}). If the aircraft manufacturer has published an initial flap extension speed, a white triangle will be presented on the airspeed tape at this speed.

Redline or Barber Pole airspeed limits that vary with pressure altitude can be displayed when configured by the installer. The colors are configured to correspond with your aircraft's approved markings on the mechanical airspeed indicator.

Textual V_{speed} markers can also be shown on the airspeed tape (e.g., V_x , V_y , V_a , etc.). These are typically programmed at installation, and (if left unlocked during installation) may also be adjusted by the pilot. V_{speed} display can be enabled or disabled by the pilot from Page 1 of the Menu (see **Chapter 5**).



Figure 2-30
Airspeed Tape

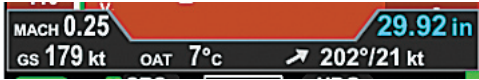

Figure 2-30a
Mach Number Display

The pilot can set a target airspeed using the Left Knob (see **Section 4.2.2.1**). The target airspeed is shown on the Airspeed Tape as an Airspeed Bug with its setting displayed numerically above the Airspeed Tape (**Figure 4-10** and **Figure 4-11**). The Airspeed Bug and numerical value are for visual reference only, to help the pilot maintain a target airspeed; there is no alerting for deviations from the target.

2.3.2.2.a. Mach Number Display for Mmo Aircraft

The Mach number for Mmo aircraft is displayed in the Data Bar (**Figure 2-30a**). The Mach number can be configured to be displayed whenever the aircraft is above the selected transition altitude or above a selected Mach number.

When the configuration is set to ALTITUDE transition, the TAS indication will be replaced by the Mach number whenever the aircraft is above the selected transition altitude.

When the configuration is set to SPEED transition, the TAS indication will be replaced by the Mach number whenever the aircraft is above the selected transition Mach number (see **Chapter 5, Table 5-2** for MACH Display setting options).

2.3.2.3. Altitude Tape, Altitude Alerter, and Vertical Speed

Altitude is indicated by a moving altitude tape against a fixed position altitude pointer (Figure 2-2, No. 21, 24), shown on the right-hand side of the Attitude Display (Figure 2-31). A numerical rolling drum readout indicating altitude values to the closest 20 feet is provided adjacent to the fixed pointer. When climbing or descending, a magenta Altitude Trend Vector displays above or below the altitude pointer, indicating the altitude that will be reached in six seconds if the current rate of climb or descent is maintained.

Minor tick marks are provided on the tape at 20-foot intervals, and major tick marks are provided at 100-foot intervals. The thousand and ten-thousand digits are larger than other digits on the tape. Negative altitudes are indicated by a “-” sign preceding the numerical altitude value in the drum.

The current altimeter barometric pressure setting is shown just below the Altitude tape in the Data Bar (Figure 2-2, No. 39), and can be adjusted by pressing the BARO Hot Key and rotating the Right Knob.

The Altitude Tape also includes a built-in Altitude Alerter, which consists of an Altitude Bug on the Altitude Tape (Figure 2-2, No. 26), a Selected Altitude Field (Figure 2-2, No. 22), a visual Altitude alert (Figure 2-2, No. 23), and an optional audio alert. For more information on using the Altitude Alerter, see *Chapter 3* and *Chapter 4*.

A Vertical Speed Indicator (VSI) is shown as a tape on the Navigation Display (Figure 2-48 and Figure 2-2, No. 57) to the right of the HSI in 360 Compass mode. A numerical vertical rate is shown in the upper right-hand corner of the Navigation Display during climbs and descents (Figure 2-2, No. 56). The VSI tape is not shown in ARC Compass mode, but the numerical value display is shown in both 360 and ARC Compass modes.



Figure 2-31
Altitude Tape



Figure 2-32
Instrument Approach Indications

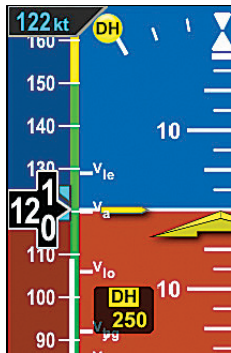

Figure 2-33
Decision Height Annunciation

2.3.2.4. Instrument Approach Indicators¹

Additional indicators are shown on the Attitude Display when flying certain types of instrument approaches. These enable the pilot to maintain a tighter instrument scan on the ADI, reducing workload and improving safety (**Figure 2-32**).

A Lateral Deviation Indicator (LDI) (**Figure 2-2, No. 37**) is presented on the attitude indicator whenever the pilot has selected an ILS, LOC, LOC Back Course (BC), or a GPS approach and valid lateral course guidance is being received. The LDI's navigation source is annunciated to the left of the LDI (**Figure 2-2, No. 31**). A Vertical Deviation Indicator (VDI) (**Figure 2-2, No. 34**) is presented on the attitude indicator whenever the LDI is shown and valid glide slope signal is being received, such as from an ILS or WAAS GPS LPV.

Whenever the lateral or vertical deviation exceeds the maximum displayable range of LDI or VDI scale (2.5 dots), the deviation diamond turns into a hollow, ghosted image pegged to the corresponding side. As soon as the deviation diamond comes into range, the diamond turns solid green, making it easy to identify when the needle is “alive”.

Additionally, the pilot can pre-set the instrument approach minimums (MIN) with the MIN Hot Key. Once the MIN data field value is set to a Decision Altitude, Decision Height, or Minimum Descent Altitude, the PFD provides a MINIMUMS annunciation when the aircraft reaches or descends below this altitude (**Figure 2-2, No. 28**). Additionally there are three minimums markers shown on the altitude tape — a green marker 500 feet above minimums; a hollow yellow triangle in the area from 100 feet to 200 feet above minimums; and a red and yellow marker at the programmed Selected Minimums value (see **Section 4.2.3.4. MINIMUMS Annunciation** for more details).

If a Radar Altimeter is installed in the aircraft and connected to the PFD, a Decision Height annunciation (**Figure 2-2, No. 27 and No. 29**) will be displayed when the aircraft descends to, or below, the selected radar altitude (**Figure 2-33**).

1. Not available with the Pilot PFD

2.3.3. Data Bar

The Data Bar visually separates the upper and lower halves of the PFD display. When available, True Airspeed (TAS) or Mach Number, GPS Ground Speed (GS), Outside Air Temperature (OAT), Wind Vector arrow, Wind Direction, Wind Speed, and Barometric Pressure Setting are presented in the Data Bar (**Table 2-8** and **Figure 2-34**).

When any of these values are not available or invalid, the corresponding data field is dashed. If the Wind Direction and Speed are not available or invalid the Wind Direction Arrow is removed. A GPS navigator must be connected and providing valid ground speed and ground track to display GS and wind data.

The Data Bar is discussed in detail in **Section 4.3**.

DATA BAR	
38	True Airspeed (TAS) or Mach Number
39	Barometric Pressure Setting Field
40	Wind Direction and Speed
41	Wind Direction Arrow
42	Outside Air Temperature (OAT)
43	Ground Speed (GS)

Table 2-7
Data Bar Components

38			39
43	42	41	40

Figure 2-34
Data Bar Components



NOTE

When the winds aloft are less than 10 knots, the wind data is not displayed.

 **NOTE**

The Vertical Deviation Indicator (VDI) and Lateral Deviation Indicator (LDI) are part of the navigation instruments and are displayed on the Attitude Display during instrument approaches.

2.3.4. Navigation Display

The lower half of the PFD is the Navigation Display (**Table 2-9** and **Figure 2-35**), which shows a wide range of navigation information and flight data, including:

- Horizontal Situation Indicator (HSI), Course Pointer and Deviation Indicator (CDI), and Heading Bug.
- 360° and ARC Compass rose display modes.
- Numeric displays of current magnetic heading, selected heading (HDG), and selected course (CRS).
- Information about the selected CDI navigation source, or active GPS waypoint.
- Ground Track Marker.
- Vertical Speed Indicator (VSI) tape and numerical rate value.
- Rate of Turn Indicator.
- Dual bearing pointers (RMI) (360° Compass mode only).
- Situational Awareness Map display.
- Course Deviation Indicators (CDI) and Bearing Pointers, navigation source information.
- GPS annunciations (TERM, APPR, WPT, and MSG).
- Caution annunciations for abnormal GPS status.

When connected to a GPS navigator, basic mapping can also be displayed under the HSI, including GPS flight plan legs and waypoints, (and when connected to a compatible GPS) Basemap data (airports, VORs, NDBs, and intersections).

NAVIGATION DISPLAY			
44	Navigation Display	58	Single-Line Bearing Pointer ¹
45	Ownship Symbol	59	Single-Line Bearing Pointer Navigation Source ¹
46	Course Pointer ¹	60	Single-Line Bearing Pointer Navigation Source Info Block ¹
47	TO/FROM Indicator ¹	61	Double-Line Bearing Pointer ¹
48	Rate of Turn Indicator	62	Double-Line Bearing Pointer Navigation Source ¹
49	Ground Track Marker	63	Double-Line Bearing Pointer Navigation Source Info Block ¹
50	Numerical Direction Indicator	64	Selected CDI Navigation Source ¹
51	Selected Course (CRS) Field ¹	65	Selected CDI Navigation Source Information Block ¹
52	Selected Heading (HDG) Field	66	Left Knob State
53	Heading Bug	67	Right Knob State
54	Course Deviation Scale ¹	68	Hot Key Legend
55	Course Deviation Indicator ¹	69	Navigation Display Range
56	Vertical Speed Numerical Value	70	Navigation Display Declutter Level
57	Vertical Speed Indicator Tape		

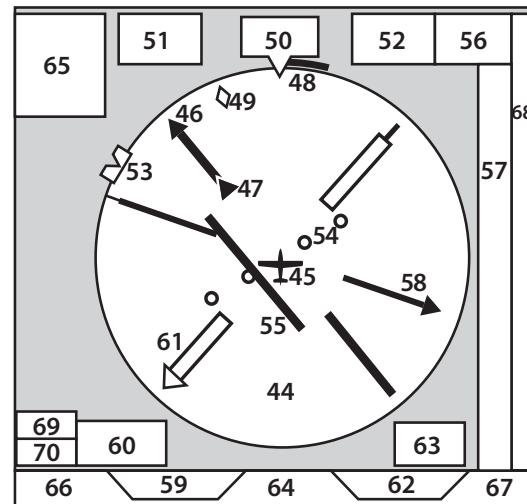

Figure 2-35
Navigation Display Components

Table 2-8
Navigation Display Components

1. Not available with the Pilot PFD



Figure 2-36
360° Compass Mode



Figure 2-37
ARC CDI Compass
Mode with Basemap

2.3.4.1. Numerical Direction Indicator (Magnetic Compass)

The center of the Navigation Display is the Numerical Direction Indicator. Like a magnetic compass, the NDI always shows the current magnetic heading of the aircraft. This slaved NDI compensates both for the turning and acceleration errors exhibited by wet compasses and for precession errors found in common Directional Gyros. The pilot does not ever need to make adjustments to the NDI.

The NDIs of both the Pilot PFD and the Pro PFD share many common features, while the Pro PFD adds features for instrument navigation.

The Pilot PFD Direction Indicator is a slaved Directional Gyro (DG) with Heading Bug.

The Pro PFD Direction Indicator adds an electronic Horizontal Situation Indicator (HSI) and dual Bearing Pointers. The HSI features are explained in **Section 2.3.4.2.**

Compass Modes: 360° vs. ARC

The NDI on the PFD can be presented in either a full 360° Compass Mode (shown in **Figure 2-36**), or in a 100° ARC mode (**Figure 2-37**).

The 360° Compass Mode resembles the mechanical instrument, with the ownship position in the center of the display.

The ARC Compass Mode provides an extended forward view with the ownship position near the bottom of the Navigation Display. The ARC Compass is especially good for displaying flight plan and basemap details.

The 360/ARC Hot Key is used to toggle the display between 360° and ARC Compass Modes, with the current mode shown in green adjacent to the Hot Key.

Navigation Information

Regardless of Compass Mode setting, the current magnetic heading is always shown at the top center of the Navigation Display (**Figure 2-2, No. 50** and **Figure 2-38**). The HDG Bug setting is shown in the Selected Heading Field (**Figure 2-2, No. 52**). This field is always visible even if the HDG Bug itself is only partially visible in ARC Compass Mode. Similarly, on the EFD1000 Pro PFD HSI, the current Course setting (CRS) (**Figure 2-2, No. 51**) is always shown, whether or not the Course Pointer itself is visible in ARC Compass Mode.

A Selected CDI Navigation Source Information Block (**Figure 2-2, No. 65** and **Figure 2-39**) is presented in the upper left corner of the Navigation Display. The Source Information Block indicates the Selected CDI Navigation Source (coupled to the CDI on the Pro PFD HSI), and its associated mode (e.g., GPS, VOR, ILS, LOC). Information is provided about the selected source, including, when available, the waypoint identifier or navaid frequency, waypoint bearing and distance, and the estimated time to the active waypoint.

Ground Track Marker

When the PFD is connected to a compatible GPS, a blue Ground Track Marker is displayed on the compass rose at the value that corresponds to the aircraft's ground track (**Figure 2-2, No. 49** and **Figure 2-40**).

When the Ground Track Marker is aligned with the Course Pointer on the Pro PFD HSI, the aircraft is tracking on, or parallel to its desired track.

To align the Ground Track Marker with the Course Pointer, turn away from the direction in which the diamond is offset from the Course Pointer (think of it as a turn to pull the Ground Track Marker toward the Course Pointer).



Figure 2-38
Magnetic Heading



Figure 2-39
Navigation Source Information Block



Figure 2-40
Ground Track Marker

2.3.4.2. Horizontal Situation Indicator (HSI)¹

The traditional HSI is an instrument that combines a slaved magnetic Heading Indicator overlaid with a rotating Course Pointer and Course Deviation Indicator (CDI). This combination helps the pilot better visualize the aircraft's position relative to the desired course. The HSI is a vast improvement over the older, separate Directional Gyro (DG) and OBS course deviation indicator, because the compass heading is always correct (slaved to a remote magnetic flux detector), and the integration of the CDI onto the compass simplifies the instrument scan and provides better situational awareness.

Pilots experienced with the mechanical HSI will find the PFD 360° Compass Mode immediately familiar. In its basic form, it is just an electronic representation of a mechanical HSI. Pilots transitioning from flying a DG and OBS should seek dual instruction from a CFII on the differences in flying an HSI.

2.3.4.3. Course Pointer and Course Deviation Indicator (CDI)¹

In the 360° Compass Mode, the Course Pointer and CDI resemble those of a mechanical HSI, with an arrowhead pointing to the selected course, and a movable center bar indicating course deviation against a scale of two dots to either side of the center. A TO/FROM indication is shown as a triangle above (TO) or below (FROM) the ends of the CDI.

The ARC Compass Mode has two different CDI formats -ARC HSI Mode and ARC CDI Mode. The ARC HSI Mode, presents a full rotating Course Pointer with a CDI, which resembles that used in the HSI in the 360° Compass Mode. The ARC CDI Mode presents a short Course Pointer stub on the compass arc and a fixed CDI at the bottom of the display, similar to the LDI and resembling that used in contemporary GPS navigation displays. The ARC CDI Mode allows more open space for flight plan and basemap details. A TO indication is shown to the left of the fixed CDI, and a FROM indication is shown to its right.

1. Not available with the Pilot PFD

2.3.4.4. Deviation Off-Scale Indication¹

Whenever the course deviation exceeds the maximum displayable range of 2.5 dots, the CDI or deviation diamond is shown as a hollow, ghosted image pegged to the corresponding side (**Figure 2-41** and **Figure 2-42**). As soon as the CDI or deviation diamond comes into range, it turns solid green, making it easy to identify when the indicator is “alive”.

2.3.4.5. Auto Course Select¹

When a GPS is selected as the CDI's navigation source, the default setting of the EFD1000 Pro PFD is Auto Course Select. When Auto Course Select is enabled, the GPS will automatically set the Course Pointer to the current GPS course (CRS) value whenever the GPS sequences between waypoints. This capability relieves the pilot from having to manually set the course at each waypoint along a GPS route. When Auto Course Select is enabled, the pilot cannot adjust the CRS value.

Auto Course Select is indicated by an inverse A on a green background, adjacent to both the numerical CRS value and the CRS Left Knob State. (**Figure 2-43** and **Figure 2-44**).

If the GPS navigator enters the OBS or HOLD mode, Auto Course Select is automatically disabled on the EFD1000 Pro PFD until the GPS navigator resumes waypoint sequencing. The pilot can disable Auto Course Select from Page 1 of the Menu.



Figure 2-41
Off Scale CDI Bar



Figure 2-42
Off Scale Deviation Diamond, ARC CDI Mode



Figure 2-43
Auto Course Indication on CRS Field



Figure 2-44
Auto Course Indication over Left Knob

1. Not available with the Pilot PFD



Figure 2-45
BRG#1 Set to GPS1 TAKLE (Single Line Bearing Pointer)

2.3.4.6. Bearing Pointers¹

The Single- (Figure 2-2, No. 58) or Double-line (Figure 2-2, No. 61) Bearing Pointers can be overlaid on the HSI (Figure 2-45). Use the Lower Left and Lower Right buttons (Figure 2-2, No. 12 and No. 10) to select the navigation sources for the Bearing Pointers, or select none (blank) to remove a Bearing Pointer from the display.

Bearing Pointers always point to a VOR or waypoint. When coupled to a VOR source, the tail of the Bearing Pointer indicates the VOR radial on which the aircraft is currently located. Bearing Pointers are excellent tools for identifying crossing radials, flying DME arcs, and improving situational awareness.

Bearing Pointers are only available in the 360° Compass Mode. Any available navigation source may be coupled to either Bearing Pointer. If coupled to a source that does not provide angular bearing data, such as a localizer, the Bearing Pointer is not shown, and the Bearing Pointer Source is slashed as invalid.

Each Bearing Pointer has an associated Source Information Block that displays information about the source of the Bearing Pointer data. This may include distance to station (if coupled to a GPS waypoint) and the tuned frequency for a VOR. This information is only presented when it is reported to the Pro PFD by the connected equipment.

1. Not available with the Pilot PFD

2.3.4.7. Rate of Turn Indicator

A Rate of Turn Indicator (**Figure 2-2, No. 48**) with a range of 0 to 6 degrees per second is provided for both the 360 and ARC Compass Modes. The indicator consists of a curved white tape that extends from the Numerical Heading Indicator's lubber line and in the direction of the turn, along the outer curve of the compass card.

The Rate of Turn Indicator features an outer thick white tick mark for a Standard Rate turn, and an inner thin white tick mark for Half-Standard Rate turns. A Standard Rate, two-minute turn equals 3 degrees per second. When the rate of turn exceeds 6 degrees per second, an arrowhead is added to the end of the tape to show that the rate of turn has exceeded the limits of the indicator (**Figure 2-46**).

2.3.4.8. Vertical Speed Indicator (VSI)

Whenever the vertical speed exceeds +/- 100 feet per minute (fpm), the vertical speed is indicated by a rising/sinking white vertical tape and associated scale markers immediately to the right of the compass rose (**Figure 2-2, No. 57** and **Figure 2-47**).

A numerical value of the aircraft's vertical speed is shown directly above the tape, in the upper right-hand corner of the Navigation Display (**Figure 2-2, No. 56**). Rates of up to $\pm 2,000$ fpm are indicated by the tape, while the numerical value will display rates of up to $\pm 9,990$ fpm. A white triangle caps the tape whenever rates exceed $\pm 2,000$ fpm (**Figure 2-48**). The Vertical Speed Numerical Value will be dashed whenever the vertical speed exceeds +/- 10,000 fpm. In the ARC Compass Mode, only the Vertical Speed Numerical Value is presented.



Figure 2-46
Rate of Turn Indicator, Rate Shown $>6^\circ/\text{second}$



Figure 2-47
VSI Tape Showing 370 fpm Descent



Figure 2-48
VSI Tape Capped, Digital Value
Showing 2,100 FPM Climb



Figure 2-49
Map in ARC Compass Mode,
20nm Range at Declutter Level 3



Figure 2-50
Declutter Level 4



Figure 2-51
Declutter Level 3



Figure 2-52
Declutter Level 2



Figure 2-53
Declutter Level 1



Figure 2-54
Declutter Level 0 (Off)

2.3.4.9. Situational Awareness Map

When the PFD is connected to a compatible GPS navigator, basemap symbols can be displayed underneath the Direction Indicator in either 360° or ARC Compass Modes. Most GPS navigators output data for the PFD to display the GPS flight plan legs and waypoints. The active GPS flight plan leg, waypoint, and its identifier are shown in magenta. Other waypoints and legs are shown in white.

Some GPS navigators (typically those using the ARINC 429 data protocol, such as the Garmin 400/500 series) output basemap data (e.g., airports, VORs, NDBs, and intersections). Often, these GPS navigators also display curved flight paths, such as arcs, course reversals, and holding patterns.

The basemap is always oriented with magnetic North heading up and centered so that the current aircraft position coincides with the aircraft ownship symbol. These basemap symbols underlay all other instruments and annunciations in the Navigation Display.

The Map Declutter Settings can be found in the 360 or ARC MAP SETTINGS page of the Menu. Pressing the desired 360 or ARC DCLTR LVL Menu Key and rotating the Right Knob will select Declutter Levels 4, 3, 2, 1, or OFF (**Figure 2-50, 2-51, 2-52, 2-53, 2-54**).

The map display range is controlled by the RNG Button (**Figure 2-2, Ref. 2**), enabling the pilot to zoom in or out on the map. Automatic declutter logic changes the map features displayed depending on the selected map range.

The current range and declutter level map settings are shown in the lower left-hand corner of the navigation display (**Figure 2-49**). The map range is displayed in nautical miles, measuring the distance from the ownship symbol to the outside edge of the compass rose. The map declutter level is indicated by one to four green parallelograms below the range value. More parallelograms indicate that more basemap features are displayed.

Chapter 3

Flying the Pro PFD

This chapter provides an overview of flying the Pro PFD on an IFR cross-country flight, explaining how to access and change the necessary settings of the PFD. Refer to **Chapter 4** for detailed step-by-step instructions for all PFD functionality.

While you can jump right in to using the PFD with this chapter, it may be helpful to first read **Chapter 2** to become more familiar with the controls, operating logic, and display elements of the PFD.

The PFD is a powerful Electronic Flight Instrument System (EFIS), offering the same capabilities and features found in larger glass cockpit systems in airliners, business jets, and newer general aviation aircraft. It is capable of far more than the analog instruments it typically replaces. It will take some time and experience to master all of its advanced capabilities, especially if this is your first exposure to flying an EFIS and a glass cockpit. Nonetheless, in its most basic configuration, the PFD will look immediately familiar to anyone accustomed to flying mechanical instruments, and its basic operation is very similar and intuitive.

Before flying your new PFD on an actual IFR flight, first be sure to spend some time with your installer to understand exactly how your aircraft is configured. It's also recommended to get some dual instruction and practice in VFR conditions until you are comfortable with how the PFD performs and integrates with the other avionics in your airplane.

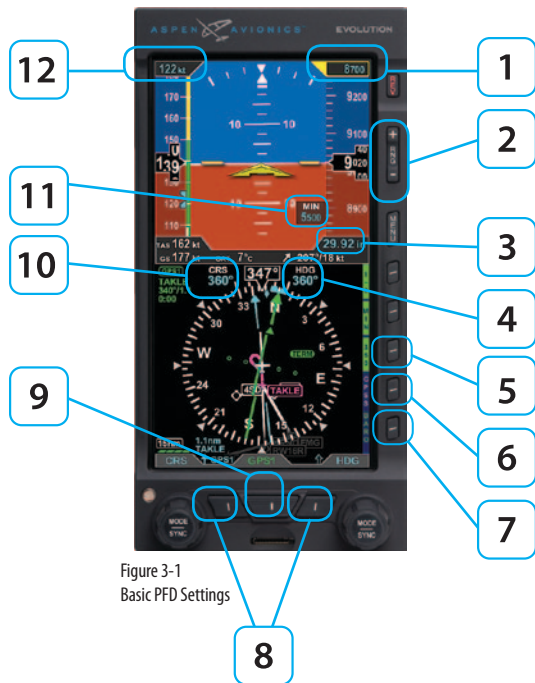

Figure 3-1
Basic PFD Settings

FEATURE	SETTING	FEATURE	SETTING		
1	Selected Altitude	Set as desired	7	Barometric Pressure (BARO) Hot Key	Allows for BARO adjustment
2	Map RNG (Range) Buttons	Set as desired	8	Lower Left and Right Buttons, Bearing Pointers Nav Source ¹	Select as desired
3	Barometric Pressure Setting Field	on/off	9	CDI Navigation Source Select ¹	Select as desired
4	Heading Bug Value	Set as desired	10	Selected Course (CRS) Pointer Field ¹	Set as desired
5	Compass Mode Hot Key: 360 or ARC	Set as desired	11	MINIMUMS Setting ¹	Set approach minimums
6	GPS Steering (GPSS) Hot Key ¹	on/off	12	Selected Airspeed	Set as desired

Table 3-1 Basic PFD Settings

1. Not available with the Pilot PFD

3.1. Quick Controls Overview

Chapter 2 explains the PFD controls in detail. The following is a quick summary:

Knobs

*(See **Chapter 2, Section 2.2.1.** for details)*

The Left or Right Knob each has a Home State, to which it returns after 10 seconds of inactivity. The Left Knob is the CRS Knob, and the Right Knob is the HDG Knob.

- The current function of each knob is shown by its State, displayed immediately above the knob. If the knob state is shown in magenta, turning the knob will change the value of the function shown. If the legend is shown in cyan or green, turning the knob will have no effect.
- From the Home State, pressing the knob once will enable the current function to be set (Knob State color changes from cyan to magenta). Successive presses of the knob will cycle through the functions that knob can control. When the function you want to change is shown in magenta, turning the knob will change its value.
- The Left Knob sets the Course Pointer (CRS, except when Auto Course Select is enabled) and Indicated Airspeed Bug (IAS).
- The Right Knob sets Heading (HDG), Selected Altitude (ALT), Barometric Pressure Setting (BARO), and Approach Minimums (MIN).
- Pressing and holding a knob syncs the selected function.

Navigation Source Buttons

- Three Buttons at the bottom of the display couple the available navigation sources to the CDI and the Bearing Pointers.
- The Center Button - CDI Navigation Source Select Button (**Figure 2-2, Ref. 11**) selects the nav source to couple to the CDI and to drive the autopilot (if installed).
- The Lower Left Button and Lower Right Button (**Figure 2-2, Refs. 12 and 10**) select which nav source couples to each of the two Bearing Pointers or none to hide the bearing pointers (see **Chapter 2, Section 2.2.2** for details)

Hot Keys

- The five keys on the lower right-hand side of the display are Hot Keys, the function of which is shown by the legend on the screen immediately adjacent to each key.
- The current status of each Hot Key is shown by the legend in a green label and dark blue letters if active or in a blue label and green letters if inactive.
- Each press of a Hot Key will either toggle its function on or off, or will cycle among available settings (see **Chapter 2, Section 2.2.3** for details).

3.2. Example Flight Scenario

This section will walk you through using the Pro PFD on an IFR flight from Albuquerque International Sunport (KABQ) to Reno/Tahoe International Airport (KRNO), flying Victor airways to the ILS16R approach into KRNO. This scenario uses one pilot's technique for setting up the navigation instruments, but there are many other valid possibilities. Use whatever techniques work best for you.

Our aircraft for this example flight scenario is a Beechcraft Baron P58TC, equipped with dual Garmin GNS-430W WAAS GPS/Nav/Comm and the Bendix/King KFC-200 Autopilot. The Pro PFD is configured with Auto Course Select enabled, BARO setting in inches Hg, Vspeed text markers displayed, ARC compass mode in CDI, and Basemap configured with its default settings.

The Garmin 430Ws are configured with ILS CDI Capture set to AUTO, meaning that when an ILS approach is loaded and active in the GPS, and the aircraft is established inbound to the FAF, the 430W will automatically switch its CDI output from GPS to the VHF localizer frequency. The PFD will follow this switch on its CDI Navigation Source Select, automatically changing from GPS1 to VLOC1.



NOTE

The tasks and procedures you will use in your airplane will vary depending on your aircraft and equipment, and on how they are configured and integrated with the PFD in your specific installation

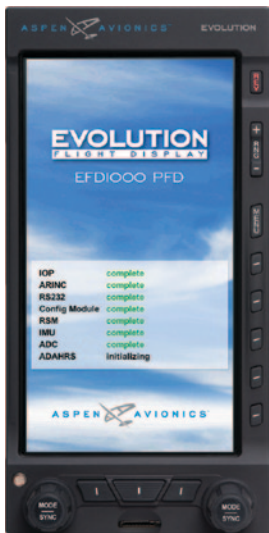

Figure 3-2
EFD1000 PFD Initializing



Figure 3-3
CDI Navigation Source Slashed Invalid

3.2.1. Pre-Departure (Startup)

Once the pre-flight inspections and checklists are complete, start the engines and turn on the PFD Master switch.

When power is applied to the PFD, the bezel backlighting illuminates and within a few seconds the PFD splash screen displays while it initializes and the AHRS data is validated (**Figure 3-2**).

As the software initializes and the PFD warms up, the Attitude and Navigation Displays will appear first (typically within 20-30 seconds), with red X's showing for the airspeed and altitude tapes and the CDI Navigation Source is slashed as invalid (**Figure 3-3**). Depending on how cold the aircraft is, the air data sensors will quickly warm to operating temperature, and the airspeed and altitude tapes will appear. At this point, the red X's will disappear and, the PFD is ready.

NOTE

Start-up times for the PFD are highly dependent on aircraft temperature. In extremely cold weather, when the aircraft has been cold soaked, it may take several minutes (usually no more than five) for the PFD to be fully operational. On the second or third flight of the day, and/or on very hot days, the PFD may initialize within 30 seconds or less.

Turn the Avionics Master ON. Until the navigation radios are operational, the CDI Navigation Source annunciations on the PFD is slashed as invalid (**Figure 3-4**), and the GPS1, GPS2 caution annunciations on the left (**Figure 3-5**), and INTEG caution annunciated on the right edge of the display. The CDI Navigation Source Select will default to VLOC1 the first time the PFD is turned on. After that the CDI Navigation Source Select will display the last used CDI Source. Once the nav radios have warmed up, the red line will be removed from the CDI Navigation Source annunciation.



Figure 3-4
CDI Source Slashed Invalid



Figure 3-5
GPS Caution Annunciations

NOTE

GPS navigators will not output valid navigation information until programmed with an active flight plan or direct-to waypoint, and thus will be treated as invalid by the PFD and cannot be selected as a CDI or Bearing Pointer navigation source until they are programmed with an active waypoint.

When the PFD is interfaced to a Garmin 4xx /5xx or 4xx(W)/5xx(W) navigator, and the navigator’s Instrument Panel Self-Test page is displayed, the indicated lateral deviation can be verified on the Pro PFD CDI. This confirms that a valid digital signal has been received from the Garmin system.

The interface between the Garmin 4xx/5xx and EFD1000 system should be considered fully operational once the presence of the digital signal is confirmed. If there is no GPS failure annunciation on the PFD the lateral deviation indication on the PFD HSI correlates to the indication on the Garmin 4xx/5xx Instrument Panel Self-Test Page, and then the digital signal is confirmed, and the interface is operational.

NOTE

The graphics used in this chapter illustrate the descriptions of the features and tasks, but do not necessarily correspond to the values associated with this example flight scenario.

WARNING

Whenever there is a new altimeter setting, set both the PFD and the standby altimeter.



Figure 3-6
BARO Setting Field Enabled



Figure 3-7
BARO Setting Field Disabled

The navigator's indicated lateral and vertical deviations cannot be compared to the EFD1000's Lateral Deviation Indicator (LDI) and Vertical Deviation Indicator (VDI) because the 4xx/5xx Instrument Panel Self-Test Page does not send an Approach Mode signal to the EFD1000 Pro PFD.

Once the radios are available, we listen to the ATIS and learn that the local altimeter setting is 30.15 and that Runway 8 is in use for departures.

First set the standby altimeter to 30.15, and then set the PFD barometric pressure setting.

Set the Barometric Pressure

1. Press the BARO Hot Key. The BARO label above the Right Knob and Barometric Pressure Setting Field appear in magenta - enabled for editing (**Figure 3-6**).
2. Rotate the Right Knob clockwise to increase or counterclockwise to decrease the value of the Barometric Pressure Setting Field.
3. Once the correct value is selected, press the BARO Hot Key or any knob, button/key to exit the BARO function. After 10 seconds of inaction or if any other button/key is pressed, the BARO function is disabled and the Right Knob returns to normal operation (**Figure 3-7**).

Next, since we'll be departing from Runway 8, we set our Heading Bug to runway heading, 080°.

Set the Heading Bug

1. Press the Right Knob until HDG displays above the knob and the HDG field is enabled for editing, both rendered in magenta (**Figure 3-8**). The Heading Bug will also be rendered in magenta, and a dashed magenta line will extend from the ownship symbol to the Heading Bug to make it easier to see the bug position.
2. Rotate the Right Knob to change the value of the Selected Heading field. Rotate clockwise to increase, or counterclockwise to decrease, the value. Once the correct heading is selected and after 10 seconds of inaction, the field is disabled, and the label and field are rendered in cyan (**Figure 3-9**).

We call Clearance Delivery to pick up our IFR clearance. It is:

Baron N1234 is cleared to the Reno/Tahoe Airport via the LARGO2 departure, Zuni (ZUN) transition, then as filed; Maintain 7,000; Expect 10,000 in five minutes; Departure frequency is 127.4; Squawk 0123.

We copy and read back our clearance, and then set up our avionics for an instrument departure. We set our transponder code and comm radio frequencies. Then we enter our flight plan into GPS1, load the LARGO2 departure, crossfill into GPS2, and activate the flight plan. We make sure the CDI button on the 430W is set to GPS.

The LARGO2 departure calls for vectors to our route. From past experience, we expect to be vectored past ABQ VOR, and then given a vector to join the departure on the ABQ-to-ZUN leg (a 255° course). While we navigate with GPS, for situational awareness, we tune those first two VOR fixes into our nav radios. We tune the ABQ VOR (113.2) into VLOC1 and the ZUN VOR (113.4) into VLOC2.



Figure 3-8 Selected Heading Field Enabled



Figure 3-9 Selected Heading Field Disabled



Figure 3-10
CDI Navigation Source Selection Button



Figure 3-11
Bearing Pointer Nav Source Select Buttons



NOTE

When no source is selected, only the Bearing Pointer icon is shown above the applicable button (Figure 3-12).



Figure 3-12
No Bearing Pointer Sources Selected

Select GPS1 as the CDI Navigation Source. Because we have enabled Auto Course Select, the Course Pointer automatically slews to 261° (the initial course from the airport to the first fix on the LARGO2 departure, ABQ VOR).

Select the CDI Navigation Source

- Press the CDI Navigation Source Select Button (**Figure 3-10**) until the desired navigation source is shown above the Button (in this case, GPS1).

For a traditional RMI view, we could use our two Bearing Pointers to monitor our passing the ABQ VOR and then intercepting the course to ZUN. We'd use the left, Single-Line Bearing Pointer Source Select Button to select VOR1 (ABQ), and use the right Double-Line Bearing Pointer Source Select Button to select VOR2 (ZUN). Since the ZUN VOR is too far away to receive on the ground at Albuquerque, VLOC2 will be shown with a red line through it above the Double Bearing Pointer Source Select Button, and the Double-Line Bearing Pointer will not be displayed. But we know that the station will be received, and the pointer will be shown, by the time we climb to our initial cruise altitude.

Select Bearing Pointer Nav Sources

- Press the Lower Left Button (Single-Line Bearing Pointer) or the Lower Right Button (Double-Line Bearing Pointer) until the desired navigation source is shown above the Button (**Figure 3-11**).

For even better situational awareness, we choose to display the map of our flight plan legs and waypoints. We press the MAP Hot Key to bring up the Basemap. We use the Range Control Buttons to select the 20nm range, which will give a good perspective for intercepting the course to ZUN. Our initial flight plan leg, from the airport to the ABQ VOR, is shown in magenta, with subsequent legs and waypoints shown in white.

Select Map Declutter Level

The Map Declutter function can be found in the 360 MAP SETTINGS page or in the ARC MAP SETTINGS page of the MENU (Figure 3-13). The Map Declutter Icon is located on the bottom left of the Nav Display (Figure 3-13a). The Declutter settings can be configured to Levels 4, 3, 2, 1, or 0 (Figures 3-13b thru 3-13f) (see Chapter 5, Table 5-9 for more details).

To change the Map Declutter Level

1. Press the MENU Button and rotate the Right Knob to the 360 MAP SETTINGS or the ARC MAP SETTINGS page.
2. Press the DCLTR LVL Menu Key and rotate the Right Knob to select the desired declutter level, then press MENU Button to exit.

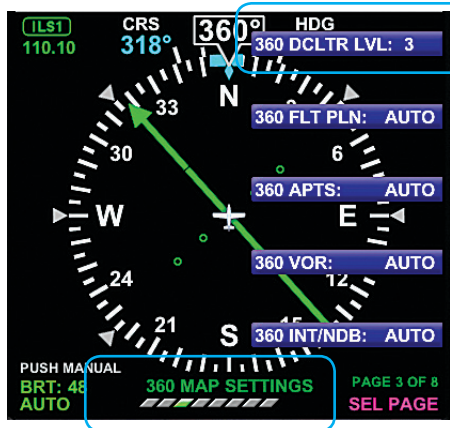

Figure 3-13
Changing the Map Declutter Level

NOTE

The Basemap symbols and flight plan legs rendered for each of the map's declutter levels (4, 3, 2, 1, or 0) are based on the selected map range. These are manually configured to display or not in the Main Menu. Detailed information is provided in Chapter 5, Section 5.2.

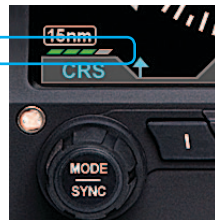

Figure 3-13a
Map Declutter Icon Location



Figure 3-13b
Declutter Level 4



Figure 3-13c
Declutter Level 3



Figure 3-13d
Declutter Level 2



Figure 3-13e
Declutter Level 1



Figure 3-13f
Declutter Level 0



Figure 3-14
Range Button

Change the Map Range

- Press the RNG (Range) Buttons (Figure 3-14) UP (+) to increase the range, or DOWN (-) to decrease the range, until the desired range is shown (Figures 3-15 and 3-16).



Figure 3-15
Current Range 20nm from Ownship to Edge of Compass Rose



Figure 3-16
Current Range 10nm from Ownship to Edge of Compass Rose

Aspen's Evolution Hazard Awareness (EHA) option allows the EWR50 XM WX Data Link Weather Receiver, WX500 Stormscope®, and Traffic system to be connected to the Pro PFD. These options enable weather and traffic hazards to be overlaid on the Navigation Display.

Our pre-flight weather briefing noted a line of thunderstorms west and south of Albuquerque, moving northeast at 15 knots. Our flight plan route should keep us clear of the weather, but we want to check the latest NEXRAD images before departure just to be sure. So we zoom the map out to its farthest range and turn on the Data Link NEXRAD Precipitation and Lightning overlays to see how things look along our route of flight. (In flight, we'll also use our WX500 Stormscope® for real-time lightning detection, but on the ground, Data Link Lightning will give us a better indication of where the thunderstorms are located).

Display the Data Link Weather

1. Display the 2/2 Hot Key Menu.
2. Press the NXRD Hot Key to turn Data Link Weather on (label turns inverse green) **Figure 3-17**.

Display the Lightning Overlay

1. Display the 2/2 Hot Key Menu.
2. Press the LTNG Hot Key until the desired overlay is selected (LTNG, STRK, or CELL). **Figure 3-18** shows STRK selected.

We see the storms are still moving about as forecast and that our planned route still looks like it will keep us well clear. We leave the Weather overlays turned on so we can monitor them in-flight, and then zoom the map back to the 20nm range for departure.

Since the Albuquerque area is sometimes busy with VFR traffic, turn on the Traffic overlay.



Figure 3-17
Data Link Weather Overlay On



Figure 3-18
Lightning Overlay On Displaying WX-500 Strike Data



Figure 3-19
Traffic Overlay On
(Traffic Normal selected)

Display the Traffic Overlay

1. Display the 2/2 Hot Key Menu.
2. Press the TRFC Hot Key to select the desired Altitude Filter. The label turns inverse green for TFCN (Normal), TFCU (Unrestricted), TFCA (Above), and TFCB (Below). The TRFC annunciation displays in the lower left of the display (**Figure 3-19**).
3. Press the 1/2 Hot Key Menu for access to GPSS for departure.

Altitude Alerter

Next, we set our assigned initial altitude of 7,000 feet in the Selected Altitude Field which enables the Altitude Alerter. We press the Right Knob twice, changing the legend above the knob to ALT in magenta. Then we turn the Right Knob to set 7,000. This will help us capture and maintain our assigned altitude.

NOTE

Setting the Altitude Alerter provides visual and aural cues to help the pilot capture and maintain target altitudes. When set to a new altitude, the Alerter will illuminate a yellow flag adjacent to the target altitude display and sound a one-second tone; 15 seconds (or 200 feet) before the aircraft will reach the target altitude (based on current rate of climb or descent). The yellow flag will extinguish once the target is reached. Subsequently, if the aircraft deviates more than 200 feet above or below the target altitude, the flag will again illuminate, and another one-second tone will sound to alert the pilot to the deviation.

Set the Altitude Alerter

1. Press the Right Knob until ALT displays above the Right Knob and the Selected Altitude numerical field and Bug are enabled for editing, all three rendered in magenta (**Figures 3-20 and 3-21**).
2. Rotate the Right Knob to change the value of the Selected Altitude field. Rotate clockwise to increase, or counterclockwise to decrease, the value.
3. Once the correct value is selected, and after 10 seconds of inaction, the field is disabled and the label, Selected Altitude field, and Bug are rendered in cyan (**Figure 3-22**).

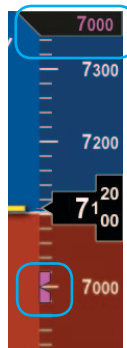

Figure 3-20
Altitude Bug Enabled



Figure 3-21
Altitude Field Enabled

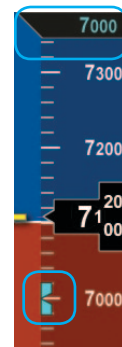

Figure 3-22
Altitude Bug Disabled



NOTE

Synchronizing the altitude sets the selected altitude to the current altitude (see **Chapter 2, Section 2.2.1.3.**)

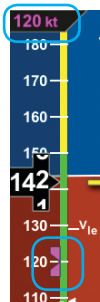

Figure 3-23
Selected Airspeed Field Enabled



Figure 3-24
Selected Airspeed Field Enabled

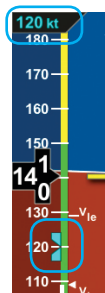

Figure 3-25
Selected Airspeed Field Disabled

Our normal climb speed is 120 KIAS, so we set the Airspeed Bug as a reminder. To do so, we press the Left Knob twice, until it shows IAS in magenta above the knob. Then turn the knob until 120 shows in the Selected Airspeed Field.

Set the Airspeed Bug

1. Press the Left Knob until IAS displays above the Left Knob and the Selected Airspeed field and bug are enabled for editing, all three rendered in magenta (Figures 3-23 and 3-24).
2. Rotate the Left Knob to change the value of the Selected Airspeed field. Rotate clockwise to increase, or counterclockwise to decrease, the value.
3. Once the correct value is selected, and after 10 seconds of inaction, the field is disabled, and the label and field are rendered in cyan (Figure 3-25).

We plan to hand-fly the plane until reaching our final enroute altitude of 10,000 feet, but would like to use the Flight Director (FD) (Figure 3-26). So, as part of our Before Takeoff set-up, we press the FD button on the autopilot mode selector, and the magenta V-bars display on the PFD. As an easy way to give us guidance on the takeoff, we press the Go Around button. This commands wings level and about a 10° pitch-up attitude, which works well for our initial climb.

Now our avionics are all set, so we taxi out to the runway, do our run-up, and call tower, ready for departure. As we taxi into position and hold on Runway 8, we verify that our PFD compass shows 080°, lined-up with our pre-set Heading Bug. As tower clears us for takeoff, it tells us to wait until reaching the end of the runway, and then to turn left to heading 250°. Rotate the Right Knob to set the Heading Bug to 250°.

NOTE

*Synchronizing the airspeed sets the selected airspeed to the current airspeed (see **Chapter 2, Section 2.2.1.3.**)*

3.2.2. Departure

As we start the takeoff roll, we note the airspeed on the PFD comes “alive” at 20 KIAS. All indications are normal, so we continue the takeoff, rotate at 80 KIAS and fly the Flight Director command bars at 10° pitch up with wings level. As we run out of usable runway to land, we bring the gear up, and soon we’re over the end of the 13,800 ft. runway.

We engage HDG mode on the autopilot mode selector, and the FD commands a left turn to our assigned 250° heading, which we have already set with the Heading Bug. Through 1,000 feet AGL, we power back and adjust the pitch attitude to maintain our target 120 KIAS climb speed, as shown by the Airspeed Bug on the airspeed tape, and set the FD pitch to that attitude.

Soon we hear a one-second tone and see the yellow flag appear next to our Selected Altitude field at the top of the PFD airspeed tape (**Figure 3-27**). This means we are 15 seconds away from reaching our assigned altitude. We begin to shallow our climb, and level off at 7,000 feet, engaging ALT hold on the AP/FD mode selector. The yellow Altitude Alert on the PFD goes out as we capture and hold our altitude.

While on the 250° vector, we pass abeam the ABQ VOR. The Single-Line Bearing Pointer points abeam, toward the VOR, and then swings behind the aircraft. We also notice that the GPS then sequences to the next flight plan waypoint, the ZUN VOR.. The PFD Course Pointer automatically swings left to the new course, 255°, and the leg on our Basemap turns magenta.

Albuquerque Departure now tells us to fly heading 220° to join the LARGO2 departure, and climb and maintain 10,000. Departure also calls out slower traffic at our 10 o’clock, seven miles, west-bound at 8,000, and asks us to expedite our climb through 8,000.

1. Rotate the Right Knob and turn it left to set the Heading Bug to 220°.
2. Press the Right Knob twice to activate ALT, and turn it right to set 10,000 in the Selected Altitude field at the top of the Altitude Tape.

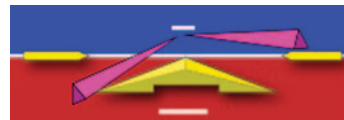

Figure 3-26
Flight Director V-bars



Figure 3-27
Altitude Alerter Flag Illuminated



Figure 3-28
CDI Shown Hollow at Full-Scale Deflection



Figure 3-29
CDI "Alive" and Shown Solid

Auto Course Select has already set our Course Pointer to the 255° course from ABQ to ZUN on the LARGO2 departure, and a 220° heading sets us up for a nice intercept. We disengage ALT hold on the autopilot, set our cruise climb attitude and power, set the V-bars to that pitch, and initiate the climb from 7,000 to 10,000 feet. We pitch a little higher to climb at 115 KIAS through 8,000 for traffic, then lower the nose to maintain our target airspeed of 120 KIAS by reference to the Airspeed Bug.

Even though our traffic should be right ahead of us and about five miles by now, we don't see it out the window. But we see the traffic target on our PFD Navigation Display and continue to monitor it even though it appears not to be a factor.

At about 9,700 feet, the Altitude Alerter tone sounds, and the yellow alert flag by the Selected Altitude field illuminates, telling us we are 15 seconds from reaching our assigned 10,000 feet. We begin our level-off, and upon reaching 10,000 feet, engage ALT hold on the autopilot's mode selector.

Departure calls again to hand us off to Albuquerque Center on 133.0. As we're tuning the radio, we hear an alert tone. A glance at the PFD shows the Altitude Alerter flag flashing, our altitude indicates 10,200 and climbing, and our Flight Director V-bars are commanding pitch down. We quickly stop the climb, correct back down to our assigned altitude of 10,000, and engage the autopilot before calling to check in with Center.

As we level out, accelerate to cruise speed, and then power back, we finally see our traffic out the left window, same direction, now about two miles and 2,000 feet below us — just where the traffic symbol on our PFD says it should be.

3.2.3. Enroute

Albuquerque Center gives us a new altimeter setting of 30.11. We set 30.11 on the standby altimeter and then on the PFD.

- Press the BARO Hot Key and rotate the Right Knob to set 30.11.
- Press the BARO Hot Key, or any knob, button/key to exit.

Soon, the CDI comes “alive” and attracts our attention as it changes from hollow (**Figure 3-28**) to solid green (**Figure 3-29**) and begins to move in towards the Course Pointer as we intercept our course. We enable GPSS to complete the intercept and steer us along the airways all the way to Reno, and engage the autopilot.

Engage GPSS

1. Press the GPSS Hot Key to Enable GPS Steering (**Figure 3-30**).
2. Verify indications that GPSS is now enabled on the PFD.
 - The GPSS legend adjacent to the GPSS Hot Key should be shown in inverse green.
 - The annunciation GPSS1 (or GPSS2, depending on the selected CDI Navigation Source), along with an inverse A, should be shown next to the HDG reference at the top of the navigation display (**Figure 3-31**).
3. Select HDG mode on the autopilot’s mode selector.
 - The Flight Director V-bars should be showing appropriate steering cues to intercept and track the course.
4. Engage the autopilot (if desired).



Figure 3-30
GPSS Enabled Legend in Green



Figure 3-31
GPSS Enabled



Figure 3-32
360° Compass Mode



Figure 3-33
ARC CDI Compass Mode

NOTE

Each HSI Compass Mode (360 and ARC) retains its own Range and Map declutter settings when switching between the two.

With GPS Steering (GPSS), a compatible GPS navigator (in this case, a Garmin 430W) drives the autopilot directly via the autopilot's HDG mode, telling it how to bank to stay centered on course. GPSS can drive the autopilot far more accurately than the NAV mode (which is based on course deviation indications) because the GPS always knows the ground track and how to adjust to maintain that track, implicitly accounting for changing wind conditions. The GPS also includes turn anticipation based on current ground speed and track, enabling it to turn early and roll out centered on the new course without overshooting. As we'll soon see when flying an instrument approach, an autopilot with a WAAS GPS and GPSS enabled can even fly procedure turns and holding patterns. For more detail on GPSS (see **Chapter 4, Section 4.7.1.**).

Now that we're established at our final cruise altitude and in the enroute phase of our flight, we'll switch to the ARC Compass mode of the HSI to maximize a forward view.

1. Press the 360 Hot Key and observe that HSI changes to its ARC Compass mode and the Hot Key label changes from 360 to ARC.
2. Press the RNG Buttons to adjust the map range to suit your preference.

Select a Compass Mode

- Press the 360/ARC Hot Key to alternately select either the 360° (**Figure 3-32**) or the ARC (**Figure 3-33**) Compass Mode.

We set cruise power and lean the mixture. As the airplane stabilizes in cruise, we check the Data Bar to monitor performance. True Airspeed (TAS) is close to book performance for this altitude and power setting. OAT is close to ISA. Winds aloft are close to forecast, about a 30° left quartering headwind at 15 knots, so we'll expect to gain some ground speed due to a stronger tailwind component when we turn northwest toward Reno.

Check TAS, GS, and winds and temperature aloft on the Data Bar (**Figure 3-34**).

Ahead, we can see out the window some threatening convective buildups, those that were mentioned in our weather briefing and which we checked using Data Link Weather on the ground in Albuquerque. We still have the NEXRAD precipitation (NXRD) and Data Link Lightning (LTNG) overlays selected, and the PFD Nav Display shows the weather clearly ahead of us. For a more real-time look at lightning activity in the buildup, we switch to our WX500 Stormscope® and see lots of strikes appearing as we also see the lightning flashes out the window.

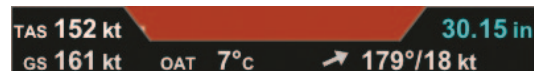

Figure 3-34
Data Bar

Display the Lightning Overlay

1. Display the 2/2 Hot Key Menu.
2. Press the LTNG Hot Key until the STRK label is shown in green next to the Hot Key (**Figure 3-35**).
3. The STRK mode annunciation appears in the lower left-hand corner of the Navigation Display, showing a yellow X for Strike mode, and a strike rate of 6 (moderate lightning activity) (**Figure 3-36**).

Fortunately, the Nav Display shows our flight plan will make a right turn at Winslow (INW) and a another right turn at Flagstaff (FLG), which will keep us clear of the weather.

Continuing enroute, we monitor progress along our flight plan on the extended forward view of ARC mode, watching as GPSS keeps us exactly centered on course through several turns on the airways.



Figure 3-35
Lightning Overlay On Displaying WX-500 Strike Data



Figure 3-36
WX-500 Strike Rate Annunciation

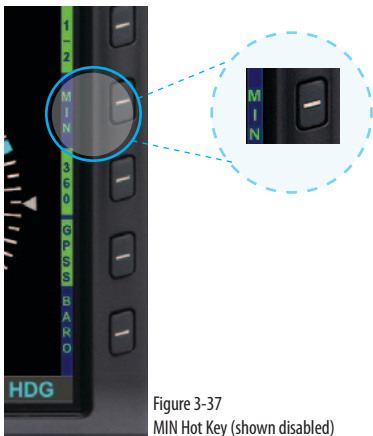

Figure 3-37
MIN Hot Key (shown disabled)



Figure 3-38
MIN Display Selected for Editing

3.2.4. Arrival and Approach to Landing

As we near Reno, we prepare for our arrival. Within range, we pick up the ATIS:

Reno-Tahoe International Airport, Information Romeo, 2253 Zulu. Winds 180 at 17. Ceiling 1,400 broken. Temperature 23, dewpoint 18, altimeter 30.08. ILS16R approach in use. Advise on initial contact you have Information Romeo.

Our route along V105 brings us to the Mustang VOR (FMG), which has a published transition to TAKLE, an Initial Approach Fix (IAF) for the ILS RWY 16R instrument approach procedure. Because we'd like some practice with our new PFD and GPSS, we'll ask to fly the full procedure with pilot nav.

We load the KRNO ILS16R approach into the GPS, selecting TAKLE as our IAF and the ILS frequency (110.9) is placed in the standby window of the 430W. With Auto Course Select enabled on the PFD, the HSI Course Pointer will be slewed automatically once we turn inbound to the Final Approach Course of 164°. Briefing the approach, we load the Ground and Tower frequencies into our #2 comm and note our Decision Height is 6,446 feet. We set our approach MINIMUMS on the PFD to 6,450 feet (MINIMUMS are set in increments of 10 feet, so we round up), and we set our Selected Airspeed for the approach at 120 KIAS.

1. Press the MIN Hot Key (**Figure 3-37**).
The Selected Minimums Field appears on the lower right-hand corner of the Attitude Display and the Right Knob State changes from HDG to MIN in magenta, ready for setting (**Figure 3-38**).
2. Turn the Right Knob to set 6,450 on the Selected Minimums Field.
3. Press the Left Knob twice to select IAS for editing.
4. Turn the Left Knob to set 120 kt as our target airspeed.

We're all set up for the approach. Nearing Mustang VOR (FMG), Oakland Center hands us off to Reno Approach, and we request nav for the ILS16R. Approach gives us the new altimeter setting of 30.08, clears us down to 9,000 feet, and after FMG direct TAKLE. We initiate the descent, set 30.08 in the standby altimeter and on the PFD:

1. Press the Right Knob twice to select ALT for editing.
2. Turn the Right Knob left to set 9,000 as our Selected Altitude.
3. Press the BARO Hot Key to select BARO for editing
4. Turn the Right Knob left to set 30.08 as our barometric pressure setting.

Fifteen seconds before reaching 9,000 feet, the Altitude Alerter flag illuminates, and the alert tone sounds. We begin our level-off and re-engage ALT hold on the autopilot upon reaching 9,000 feet. We leave the autopilot in HDG mode and continue with GPSS enabled on the PFD.

Approaching FMG, the GPS turn anticipation sequences to TAKLE, our Course Pointer swings automatically from 302° to 316°, and GPSS steers us through the turn, rolling out precisely on course. We power back and select the first notch of flaps to slow down. Reno Approach calls, reports us six miles from TAKLE, and clears us for the ILS16R approach.

We activate the approach on the GPS and move the ILS frequency into the active window.

GPSS continues to steer the plane to the initial approach fix, TAKLE, and at TAKLE, turns us outbound on a 344° course for the procedure turn (**Figure 3-39**). We see the procedure turn drawn on the Basemap ahead of us, and watch it turn magenta as the



Figure 3-39
360° Mode Showing Procedure Turn,
GPSS Enabled

GPSS turns and flies the procedure turn for us, with no further pilot action required.

As GPSS completes the procedure turn and rolls out centered on our final approach course of 164°, we begin a descent down to 8,500 feet, which we will maintain until glideslope intercept.

1. Press the Right Knob twice to select ALT for editing.
2. Turn the Right Knob to set 8,500 as our Selected Altitude.
3. On reaching 8,500, re-engage ALT hold on the autopilot.

We are still navigating along the ILS16R approach using GPS, with GPSS driving the autopilot in HDG mode. We know we'll have to switch the autopilot to APPR mode before glideslope intercept in order for the autopilot to capture the glideslope and fly us down the ILS. But we'll continue in GPSS and HDG mode a while longer because it tracks the course more accurately with our aging autopilot.

Along this intermediate segment of the approach, watch for the 430W to switch automatically from GPS to VLOC output on its CDI.

- Watch for the EFD1000 CDI Source Select field to change from GPS1 to VLOC1.

This automatic switch from GPS to VLOC should occur 2–10nm outside the Final Approach Fix (FAF). If it has not occurred automatically by 2nm outside the FAF, manually press the CDI button on the 430W to make the switch to the ILS frequency, and the PFD will follow by switching its Navigation Source Select to VLOC1.

As the PFD navigation source switches to the ILS on VLOC1, the LDI and VDI (**Figure 2-2, Refs. 36 and 37**) will appear on the Attitude Display.

1. The LDI Navigation Source Annunciation (**Figure 2-2, Ref. 31**) will show ILS, if it is receiving a valid glide slope signal, or LOC, if it is not receiving the glide slope (GS).
2. The CDI Source Information Block (**Figure 2-2, Ref. 65**) will also show ILS or LOC.

Even though the PFD Navigation Source for the CDI has switched to VLOC1 and the ILS, and the CDI, LDI and VDI are showing deviations relative to the localizer and glideslope, we still have GPSS Enabled with the autopilot in HDG mode. We are not yet flying the ILS, required for this approach. GPSS is still shown in the inverse green label next to the GPSS Hot Key, and GPSS1 and an inverse A are still shown at the top of the Navigation Display where the numerical HDG value is usually shown.

The PFD now permits GPSS to be enabled even when VLOC is selected as the CDI Navigation Source.

Whenever GPSS is enabled on the PFD, and the autopilot is in HDG mode, the autopilot will fly the GPS flight plan. The autopilot must be switched to APPR mode in order to fly the VLOC source selected for the CDI and to capture and track the glideslope of an ILS, or even an RNAV approach with vertical guidance.

A couple of miles outside the FAF (TAKLE), we switch to APPR mode on the autopilot, which begins to track the localizer and is armed for glideslope capture. At this point, we could disable the GPSS by pressing the GPSS Hot Key to remove potentially confusing annunciations on the PFD, but we know our equipment well. We understand fully that GPSS is just another form of HDG as far as the autopilot is concerned, and the autopilot will not fly GPSS unless it is in HDG mode. So we leave GPSS enabled on the PFD, planning to use it to fly the Missed Approach if necessary.

With that setup, if we have to fly the Missed Approach, we'll do so by hitting Go Around mode on the autopilot and climbing straight ahead to 6,700 feet. Then we'll press the OBS button on the GPS to allow the missed approach flight plan to sequence. Engage the autopilot in the HDG mode and begin the climb out. With GPSS still enabled, the autopilot will navigate the aircraft directly to the FMG VOR. If the GPS supports curved flight plans, such as a WAAS GPS, the autopilot will automatically enter and fly the hold. All we have to do is level off when reaching 11,000 feet - and if we had Altitude Pre-Select on the autopilot, it would even do that for us, too!



CAUTION

The Garmin 400/500 series navigators continue to output GPS Steering commands to follow the GPS flight plan even when the CDI source is set to VLOC.

The PFD permits GPSS to be enabled even when VLOC is selected as the CDI navigation source.

Whenever the GPSS is on and the autopilot is in the HDG mode, the autopilot will fly the GPS flight plan. The autopilot must be switched to APPR mode in order to fly the VLOC source selected on for the CDI and to capture and track the glideslope of an ILS or even an RNAV approach with vertical guidance.



Figure 3-40
Vertical and Horizontal Deviation
Indicator, Showing Glide Slope

When the glideslope is full-scale deflection above us, the Deviation Indicator on the VDI will show as a hollow diamond at the top of the scale (**Figure 3-40**). When the glideslope comes “alive”, the Indicator will change to a solid green diamond and begin to move down the VDI. Just before intercepting the glideslope, we drop the gear and check for three green lights. At glideslope intercept, we verify that the autopilot switches to glideslope-capture and begins to fly the aircraft down the glide slope.

We continue to monitor the approach and verify that the autopilot is tracking both localizer and glide slope. The weather is well above minimums, and we intend to land out of the approach but will let the autopilot fly it down to minimums. As we get close to minimums, a green triangle appears on the Altimeter Tape at 500 feet above minimums; a hollow yellow triangle appears with its tip at 200 feet above minimums and its base at 100 feet above. A red-striped triangle appears at the MINIMUMS setting. These three color markers on the Altimeter Tape give us visual cues that we are approaching or at minimums.

On reaching the pre-set minimums (6,450 feet):

- The MINIMUMS alert displays below the Aircraft Reference Symbol in the Attitude Display (**Figure 3-41**).
- The MINIMUMS alert tone sounds three times.

We disconnect the autopilot and hand-fly the plane, continuing to fly the Flight Director and track the glide slope down to a smooth landing.

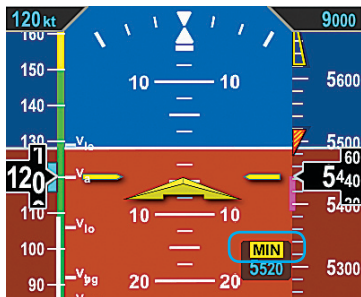

Figure 3-41
MINIMUMS Alert

3.3. Conclusion

The Pro PFD is a powerful addition to any cockpit, providing far more capability, information, and automation than the mechanical instruments it typically replaces. While it is simple and intuitive enough to start using with only a short orientation, fully understanding and exploiting all of its features require some study and experience.

Chapter 4 covers all of the Pro PFD features in detail.

Chapter 5 explains how to customize the PFD to suit your preferences.

Chapter 6 addresses Emergency and Abnormal procedures.

Please read through these chapters to fully understand how to use your PFD.

This Page Intentionally Left Blank

Chapter 4

Reference Guide

The PFD is a panel-mounted Electronic Flight Instrument System (EFIS) that presents the pilot with displays of attitude, altitude, indicated airspeed, heading, rate of turn, slip/skid, and navigation course deviation information. The system also displays supplemental flight data, such as winds, TAS, OAT, groundspeed, moving maps, pilot-selectable indices (bugs), and various annunciations to increase situational awareness and enhance flight safety. Moving map situational awareness information is displayed when the unit is connected to compatible GPS equipment.

The PFD system components include the PFD display head, a Remote Sensor Module (RSM), a Configuration Module (CM), and the optional Analog Converter Unit (ACU).

Chapter 1, Welcome and Introduction, provides a detailed discussion on the PFD system components.

When interfaced with a compatible autopilot, the Pro PFD system provides heading and course information to the autopilot, which enables the autopilot to follow the Course and Heading values set by the pilot on the PFD in much the same way as with a mechanical HSI. When interfaced with a compatible GPS, the Pro PFD can provide GPS Steering (GPSS) to an autopilot.



NOTE

The optional ACU enables the interface of the Pro PFD system with legacy panel-mounted GPS navigators, VOR/Localizer radios, and autopilots.

4.1. Air Data, Attitude and Heading Reference System (ADAHRS)

One of the many benefits of glass cockpit systems like the Aspen Evolution system is that they replace old, less-reliable mechanical instruments and sensors with electronic equivalents. For aircraft primary flight instruments, spinning metal gyros are replaced with electronic gyros and accelerometers, and mechanical air data instruments (airspeed indicator, altimeter, and VSI) are replaced by electronic sensors to measure static and ram air pressures. As we've all seen with computers and consumer goods, these modern electronic systems tend to be smaller, faster, cheaper, and more reliable than the older technologies they replace, while also enabling many new, advanced features and capabilities.

An electronic system that replaces the functions of the six primary flight instruments is often called an ADAHRS (Air Data, Attitude, and Heading Reference System). Sometimes, two separate systems work together to deliver those functions: an AHRS for attitude and heading, and an ADC (Air Data Computer) for airspeed, altitude, and vertical speed. Aspen uses an integrated ADAHRS mounted to the back of the PFD display. While such systems deliver the same basic information to the pilot as the old mechanical instruments, they work in very different ways. It is important that the pilot have at least a basic understanding of how an ADAHRS works to better understand the sorts of failure modes or degraded performance that can occur, how to recognize the symptoms, and what corrective actions the pilot can take.

The PFD uses Micro Electro-Mechanical Systems (MEMS) technology and solid-state accelerometers and magnetometers on all three axes to provide the attitude reference. Generally, MEMS attitude solutions use multiple sensors and inputs, processed through Kalman filter software, to derive and validate the attitude solution.

The Aspen system uses more than a dozen different inputs to determine and monitor the aircraft attitude. In this way, the system can validate the derived attitude indication by cross-checking the various inputs to the solution for consistency.

4.1.1. Attitude

The Aspen ADAHRS attitude solution uses inputs from its internal three-axis accelerometers, rate gyros, and magnetometers, supplemented by ram and static air pressure inputs from the aircraft pitot-static system. Failures or incorrect input from any of these sensors (such as might occur if the pitot tube or static system become blocked) will affect the attitude solution. The PFD is designed to be robust to such failures, either by being tolerant to incorrect inputs, or by detecting and annunciating a degraded attitude solution.

The Aspen ADAHRS includes a Cross-Check Monitor, which predicts the quality of the attitude solution by performing a continuous, real-time statistical analysis of the various parameters computed within the AHRS Kalman filter. When the predicted quality of the attitude calculation drops below a certain threshold, CROSS CHECK ATTITUDE is annunciated on the attitude indicator (**Figure 4-1**). The annunciation thresholds for the CROSS CHECK ATTITUDE message were determined during company flight tests, and strike a balance between minimizing nuisance annunciations (when the attitude solution is fine) and failing to annunciate (when the attitude solution is significantly degraded). This balance can occasionally result in momentary CROSS CHECK ATTITUDE annunciations, especially during aggressive maneuvering, steep or high-G turns, abrupt pitch changes, etc.

In such situations, these annunciations indicate that the statistical quality of the attitude solution is less than nominal, and that the pilot should cross-check the AHRS against alternate attitude indications. Should the annunciation persist, then degraded AHRS performance is statistically more likely to be experienced. In other words, momentary CROSS CHECK ATTITUDE annunciations indicate that the AHRS solution is working hard enough that the AHRS quality measure has degraded to something less than that associated with normal, unaccelerated flight. This situation demands increased pilot vigilance and cross-monitoring of other cockpit instrumentation.

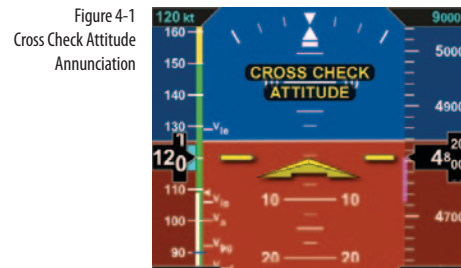

4.1.2. Pitot Obstruction Monitor

Most light aircraft have only a single pitot and static system available for flight instrument use. As such, a common pitot and static input is shared between the PFD and analog standby instruments. Should one or both of these pitot and static lines become blocked, both the PFD and any standby airspeed and altitude indicators could display erroneous airspeed and altitude information. Furthermore, because the PFD uses pitot and static pressures as part of the AHRS attitude calculations, loss or corruption of the pitot or static pressures can also influence the accuracy of the displayed attitude information.

The PFD has been tested to be robust to these failures, either by being tolerant to incorrect pitot or static inputs, or by detecting and annunciating a degraded attitude solution. When connected to an IFR-certified GPS, the system is further able to detect and annunciate blockages in the pitot system and will fail the attitude solution before it becomes degraded. In that case, the system will red X the attitude and heading information, and display a CHECK PITOT HEAT message as a reminder to the pilot to check for ice accumulating on the pitot probe.

Once the system detects that the pitot obstruction has been cleared, the CHECK PITOT HEAT annunciation is removed and the system automatically performs an AHRS in-flight reset.

Should a GPS failure be experienced in flight, the Pitot Obstruction Monitor continues to operate in a fail-safe mode and will continue to detect obstructions in the pitot system that may occur while airborne. However, after landing, the monitor remains active, and, as the airplane slows to taxi speeds, the system will indicate a failure of the AHRS and annunciate CHECK PITOT HEAT. In this circumstance, restoring the GPS will restore normal monitor operation.

In summary, loss or degradation of the PFD attitude solution is unlikely if the pilot assures the proper operation of the pitot-static system. If the pitot or static system becomes blocked, an ADAHRS internal sensor fails, or a CROSS CHECK ATTITUDE indication is frequent or persists, the attitude indication on the PFD should be considered to be compromised. In this case, the pilot must use the backup attitude indicator for attitude reference until the cause of the problem has been identified and resolved and normal system operation has been restored.

4.1.3. Heading

The PFD ADAHRS also includes a slaved compass system that provides accurate magnetic heading indications throughout most operating conditions and phases of flight. Its electronic gyros compensate for turning and acceleration errors, and its remote fluxgate compensates for gyroscopic precession errors, so there is no need for the pilot to adjust heading throughout the flight. Nonetheless, all compass systems are subject to some error, and the pilot should be aware of when and how the PFD heading indication can be affected.

The earth's magnetic field is measured directly by a 3-axis fluxgate magnetometer built into the Remote Sensor Module (RSM), and magnetic heading is derived from the flux on a plane perpendicular to gravity, providing immunity from pitching and rolling effects. Electronic gyros and accelerometers in the PFD system are then used to stabilize that raw heading data to eliminate the short-term turning and acceleration errors seen in traditional magnetic compasses.

Together, these systems provide accurate heading indications even during aggressive maneuvering. The gyros stabilize magnetic errors while maneuvering and are slaved to the fluxgate, which continuously updates heading to compensate for gyroscopic precession. The end result is a compass system that requires no pilot action to show accurate magnetic heading throughout the flight.

Just like other compass systems, the accuracy of the fluxgate is affected by its location on the airframe. Ferrous metal structures, electrical fields produced by motors, pumps, wiring, magnets in cabin speakers and other airframe-related sources of interference either constant or momentary (i.e. operating an electric trim motor, windshield heat, pumps, etc) can all affect the accuracy of the compass. The installer can compensate for much of this interference when calibrating the RSM, but some effects cannot be eliminated. Proper location of the RSM during installation of the PFD is critical to the AHRS performance and accuracy.

Furthermore, all magnetic compass systems are susceptible to local disturbances in the earth's magnetic field (some of which are shown on aviation charts or by NOTAM) and will exhibit degraded performance when operating in extreme northern and southern latitudes close to the earth's magnetic poles.

4.1.4. Free Gyro Mode

When the PFD system detects that the horizontal component of the earth's magnetic field is no longer strong enough to provide reliable heading data, the PFD will detect the condition and annunciate that the heading system is no longer slaved to magnetic north. If the condition persists, attitude and heading indications are removed.

While the condition can occur at greater distances, it is most likely to be observed within 750 nautical miles from the magnetic poles. In the Northern Hemisphere, this equates to operations in the Arctic Islands found north of continental North America.

Two minutes after detection, a FREE GYRO MODE annunciation will be presented across the HSI, indicating the heading system no longer can be aligned with magnetic north. Some precession of the heading is possible, especially during abrupt maneuvers. If the condition persists for four more minutes (six minutes total) the attitude and heading indicators will be removed and replaced with red X indications. When the conditions causing Free Gyro Mode are no longer present, attitude and heading indications will be restored after an automatic AHRS reset.

4.1.5. Degraded ADAHRS Performance

For Degraded ADAHRS Performance, reference the following:

- **Sections 6.1. Pitot/Static System Blockage**
- **Sections 6.8. In-Flight AHRS Reset**
- **Geographic Limitations** in the **Aircraft Flight Manual Supplement** that was installed in the aircraft with your PFD.

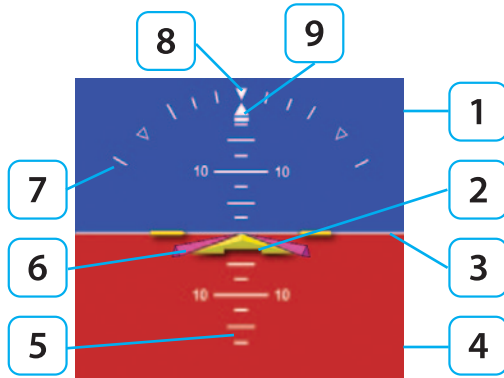

Figure 4-2
Attitude Indicator

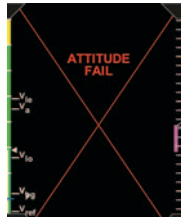

Figure 4-3
Pitch and/or Roll Data Invalid

NOTE

A red X and the annunciation **ATTITUDE FAIL** displays on the Attitude Indicator as long as pitch or roll attitude data is invalid (Figure 4-3).

4.2. Attitude Display

4.2.1. Attitude Indicator

The Attitude Indicator consists of an aircraft reference symbol on a blue (sky) and brown (ground) background. The white horizon line separates the sky from the ground and extends to the edge of the display. The Roll Scale curves over the top of the Attitude Indicator while the Pitch Scale extends vertically in the middle. The slip/skid rectangle is directly underneath the roll pointer (Figure 4-2).

- | | | | |
|---|---------------------------|---|---------------------|
| 1 | Sky | 6 | Flight Director |
| 2 | Aircraft Reference Symbol | 7 | Roll Scale |
| 3 | Horizon Line | 8 | Roll Pointer |
| 4 | Ground | 9 | Slip/Skid Indicator |
| 5 | Pitch Scale | | |

The Attitude Indicator cannot be disabled by the pilot. The Aircraft Reference Symbol is fixed relative to the Attitude Indicator and overlays all other Attitude Indicator symbols. Pitch and roll panel tilt adjustments are provided to installers to compensate for variations in installations and tilted panels.

4.2.1.1. Roll Scale

The Roll Scale is displayed at the top of the Attitude Indicator and comprises a moving scale set against a fixed, white, triangle roll pointer. Tick marks are displayed at 0°, 10°, 20°, 30°, 45°, and 60° of roll. The 45° marks are triangles.

4.2.1.2. Pitch Scale

The pitch scale consists of minor pitch marks in 2.5° increments up to $\pm 20^\circ$ and major pitch marks in 10° increments up to $\pm 90^\circ$. Red chevrons come into view for nose-up pitch angles of 15° or more (Figure 4-4), and nose-down pitch angles of 10° or less (Figure 4-5). The pitch chevrons aid the pilot in unusual attitude recovery.

The range of movement of the background sky and ground boundaries are limited so that some sky or ground is always visible.

4.2.1.3. Slip/Skid Indicator

The Slip/Skid Indicator is the small white rectangle under the roll pointer. The Slip/Skid Indicator moves left and right relative to the roll pointer in proportion to lateral acceleration. The width of the rectangle is equivalent to the width of the ball in a mechanical inclinometer.

4.2.1.4. Flight Director¹

When connected to a compatible autopilot and configured through an ACU during installation, the PFD displays a single-cue (two-axis) flight director on the Attitude Indicator (Figure 4-6). The pilot may follow the flight director's pitch and roll cues, even when the autopilot is not engaged, to remain on heading or altitude, climb or descend, turn, or navigate along a programmed flight path.

1. Not available with the Pilot PFD

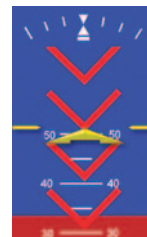

Figure 4-4
Pitch Markings
Large Pitch Down



Figure 4-5
Pitch Markings
Large Pitch Up

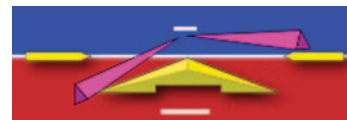

Figure 4-6
Flight Director

NOTE

Refer to the autopilot's AFMS for information on the operation of the flight director. The Flight Director is a visual representation of the pitch and roll commands from the autopilot. The Flight Director's pitch and bank limits are based on the emulation mode set at installation and are limited to $\pm 45^\circ$ roll and $\pm 25^\circ$ pitch.

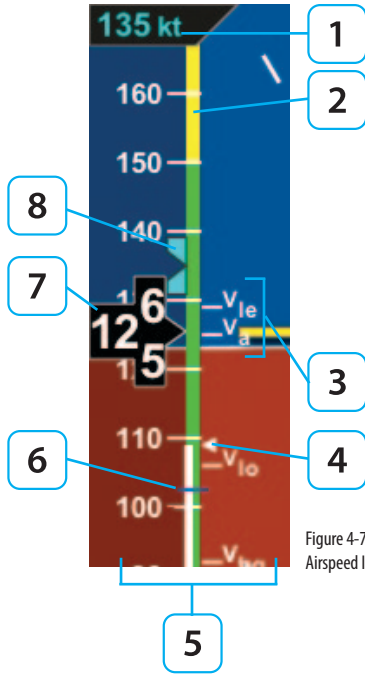

Figure 4-7
Airspeed Indicator

4.2.2. Airspeed Indicator

The Airspeed Indicator comprises a moving tape, airspeed bug, and numerical airspeed value (drum). Textual Vs speeds, color Speed Bands, and Speed Markers are also rendered on the moving tape (**Figure 4-7**).

- 1 Selected Airspeed Field
- 2 Color Speed Bands
- 3 Textual Vs speeds
- 4 Initial Flap Extension Speed Marker
- 5 Airspeed Tape
- 6 Speed Marker
- 7 Numerical Airspeed Value (drum)
- 8 Selected Airspeed Bug

Indicated airspeed is displayed in knots, miles per hour or Mach number, set at installation, with tick marks rendered on the Airspeed tape every ten (10) units. Speed Bands and Speed Markers are configured during installation and cannot be changed or removed by the pilot. The textual Vspeeds are pilot-configurable and are discussed in **Chapter 5, Customizing the PFD**. Although the pilot can set the selected airspeed (bug), there is no visual or aural annunciation provided when the actual airspeed deviates from the selected airspeed value.

The numerical airspeed value is displayed in a rolling drum format in the center of the airspeed tape with numbers moving downward as speed increases, and upward as speed decreases. The display range of the indicated airspeed is 20–450 (knots or miles per hour). The numerical airspeed value is displayed in red when Vne is exceeded or when the airspeed drops below Vs0 during stalls or landing roll-outs (**Figure 4-8**).

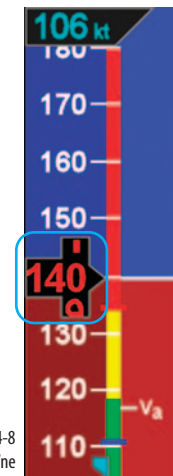

Figure 4-8
Actual Airspeed Greater Than the Vne

NOTE

When airspeed is less than 30 knots but ground GPS speed is greater than 50 knots, a red X and annunciation of CHECK PITOT HEAT is displayed on the Attitude Indicator (**Figure 4-9**).

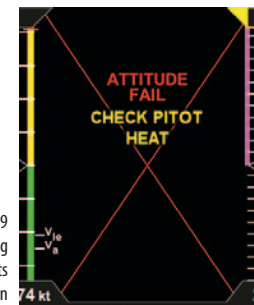

Figure 4-9
Pitot Obstruction Monitoring
Airspeed <30kts, Ground Speed >50kts
Annunciation

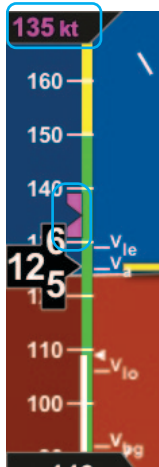

Figure 4-10
Airspeed Bug Selected to Edit

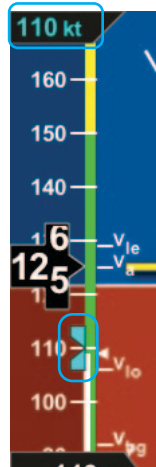

Figure 4-11
New Airspeed Selected

4.2.2.1. Selected Airspeed

The Selected Airspeed Field value and associated Airspeed Bug are shown on the Airspeed Tape. The Selected Airspeed Field value is shown at the top of the Airspeed Tape. The Airspeed Bug is displayed next to the Airspeed Tape when the Selected Airspeed value is within the visible range of the tape. The Selected Airspeed Field's default value is 20 knots Indicated Airspeed (IAS), or the value previously set. SYNCing the IAS field sets the Selected Airspeed Field value to the current indicated airspeed (**Section 2.2.1.3**). Setting the Selected Airspeed Field to a value less than 20 disables the Airspeed Bug and dashes the Selected Airspeed Field value.

Set Airspeed Bug

1. Press the Left Knob until IAS is shown above the Left Knob.

The Airspeed Field and Airspeed Bug appear in magenta - enabled for editing (**Figure 4-10**).

2. Rotate the Left Knob clockwise to increase, or counterclockwise to decrease the airspeed value in the Selected Airspeed Field.

After 10 seconds of inactivity, label, field and bug appear in cyan (**Figure 4-11**).

NOTE

A typical installation sets the Tapes (TPS) display to UNLOCKED, allowing the pilot to display or hide the Airspeed and Altitude Tapes as desired. If the Airspeed and Altitude Tapes were LOCKED ON during installation, the Tapes will remain on. If the Airspeed and Altitude Tapes were LOCKED OFF during installation, the Tapes will not display.

4.2.2.2. Airspeed Display

In some configurations, such as a stand-alone PFD, the airspeed tape can be turned off at the pilot's discretion to facilitate screen declutter. This setting will be retained when the PFD system is turned off then powered on again.

Hide/Display Airspeed Tape

1. Press MENU Button.
2. Rotate Right Knob until first Menu Key displays TPS (**Figure 4-12**).
3. Press TPS Menu Key.

TPS label and EDIT VALUE label (above Right Knob) appear in magenta.

4. Rotate Right Knob to the desired value: ENABLE or DISABLE (**Figure 4-13**).
5. Press MENU Button to exit.



Figure 4-12
Editing Airspeed Tape Display

NOTE

The Altitude Tape can also be turned off for screen declutter. Setting will be retained when PFD is turned off.

NOTE

When the Airspeed Tape is disabled, the numerical display of the selected airspeed remains. An installer can disable and remove the Selected Airspeed Field from the display.



Figure 4-13
Airspeed Tape Disabled



Figure 4-13a
Altitude Transition Setting



Figure 4-13b
Speed Transition Setting

NOTE

Refer to **Chapter 5, Table 5-3, Menu - General Settings C** for the available Altitude and Speed settings

4.2.2.3. MACH Number Display for Mmo Aircraft

For Mmo aircraft, the PFD can show aircraft Mach number in the Data Bar with a display resolution of 0.01 Mach.

The Mach number (configured during initial installation) can be displayed for either altitude or speed transition.

When configured to ALTITUDE transition, the TAS indication will be replaced by the Mach number whenever the aircraft is above the selected transition altitude.

When configured to SPEED transition, the TAS indication will be replaced by the Mach number whenever the aircraft is above the selected transition Mach number.

Select the Altitude or Speed Transition setting

1. Press the MENU Button and rotate the Right Knob to the GENERAL SETTINGS C page.
2. Press the MACH DSPL Menu Key and rotate the Right Knob to the desired Altitude setting (**Figure 4-13a**) or Speed setting (**Figure 4-13b**).
3. Press the MENU Button to exit.

NOTE

The installer will configure the PFD to display redline or barber pole airspeed limits that vary with pressure altitude. The colors are configured to correspond with the aircraft's approved markings on the mechanical airspeed indicator.

4.2.3. Altimeter

The altimeter comprises an Altitude Bug, Numerical Altitude Value (drum), Altitude Tape, Altitude Trend Vector, MINIMUMS annunciation, Selected Altitude Field value, Decision Height Annunciation, Altitude Alerter and an aural tone (when configured) DH (Figure 4-14).

- | | | | |
|----------|--------------------------|----------|---|
| 1 | Altitude Alerter | 6 | Altitude Tape |
| 2 | Selected Altitude Field | 7 | MINIMUMS Annunciation/
Selected MINIMUMS Field |
| 3 | Minimums Marker | 8 | Radio Altitude / Decision
Height Window |
| 4 | Numerical Altitude Value | 9 | Decision Height
Annunciation |
| 5 | Altitude Trend Vector | | |

The Altitude Tape range is from -1,600 to 51,000 feet. Major tick marks are provided every 100 feet and minor tick marks every 20 feet. A barometric pressure adjustment (BARO) is provided to the pilot to accurately display the aircraft's altitude above mean sea level.

The Numerical Altitude Value is shown in a rolling drum format in the center of the Altimeter Tape, with numbers moving downward as the altitude increases and upward as altitude decreases. The Numerical Altitude Value shows the altitude to the nearest 20 feet.

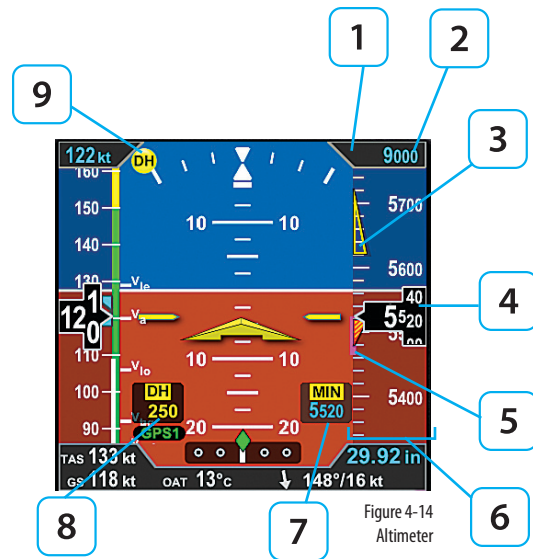

Figure 4-14
Altimeter



Figure 4-18
Editing BARO
Units of Measure
GENERAL SETTINGS B



Figure 4-19
Editing BARO
from in to mB



Figure 4-20
BARO Set to mB (millibars)



Figure 4-15
Altitude Failure

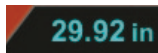

Figure 4-16
Baro Shown in Inches of Mercury

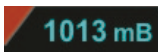

Figure 4-17
Baro Shown in Millibars

An adjacent, magenta Altitude Trend Vector predicts the anticipated altitude, in the next six seconds, if the current rate of climb or descent is maintained. Like the VSI, there is a slight lag in the indication. If the ribbon meets or exceeds the display limit, the vertical trend is large. The Altitude Trend Vector does not display when the altitude remains constant.

If the altitude exceeds 51,000 feet, the Numerical Altitude Value is dashed, and the tape is frozen at this limit. All altitude information is removed and replaced with a red X with the textual announcement of ALT FAIL when altitude data is invalid (**Figure 4-15**).

4.2.3.1. Barometric Units of Measure

Barometric units of measure adjustment may be made in either inches of mercury (in) (**Figure 4-16**) or millibars (mB) (**Figure 4-17**), as configured by the pilot in the Menu. The adjustment range is 28.10 – 30.99 inches Hg or 946 – 1049 mB. The barometric pressure default value is 29.92 inches, or as previously set.

Set Barometric Units of Measure

1. Press the MENU Button.
2. Rotate the Right Knob to select the GENERAL SETTINGS B page (**Figure 4-18**).
3. Press the BARO Menu Key.

The Menu label turns magenta, and the EDIT VALUE label displays above the Right Knob (**Figure 4-19**).

4. Rotate the Right Knob to select either in or mB (**Figure 4-20**).
5. Press the MENU Button to exit.

Set the Barometric Pressure

1. Press the BARO Hot Key.

The BARO label above the Right Knob and Barometric Pressure Setting Field appear in magenta (**Figure 4-21**).

2. Rotate the Right Knob to change the value of the Barometric Pressure Setting Field.
3. Press the BARO Hot Key or any knob, button/key to exit.

If no action is taken, after 10 seconds of inactivity, the label, and field are rendered in cyan.



Figure 4-21
BARO Field Enabled

4.2.3.2. Selected Altitude Field

The Selected Altitude Field value is displayed at the top of the Altitude Tape. The Selected Altitude Field range is 100 to 51,000 feet, in 100 foot increments. The default value for the Selected Altitude value is 100 feet, or the previously set value. Additionally, the Altitude Bug is displayed adjacent to the Altitude Tape and at the Selected Altitude Field value when within the visible range of the current altitude.

Set Altitude Bug and Altitude Alerter

1. Press the Right Knob until ALT displays above the Right Knob.

The Selected Altitude Field and bug are enabled for editing, all rendered in magenta (**Figure 4-22**).

2. Rotate the Right Knob (clockwise to increase, or counterclockwise to decrease) to change the value of the Selected Altitude Field.

Once the correct value is selected, and after 10 seconds of inaction, the field is disabled, and the label, field, and bug are rendered in cyan.

WARNING

Always check and set the PFD BARO whenever the mechanical altimeter is adjusted

NOTE

Since the altitude tape display is limited to approximately 400 feet, the altitude bug symbol is shown on the altitude tape when the Selected Altitude Field value is within the visible range of the current altitude.

NOTE

Rotating the knob quickly will change the altitude value in larger increments.

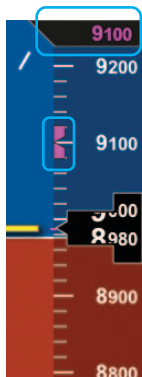

Figure 4-22
Altitude Bug and Altitude Alerter Enabled

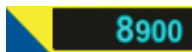

Figure 4-23
Altitude Alert

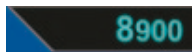

Figure 4-24
Altitude Alert Extinguishes at
Selected Altitude

4.2.3.3. Altitude Level-Off and Deviation Alert

The Altitude (level-off) Alert is ARMED and rendered on-screen as a yellow alert flag next to the Selected Altitude value when the aircraft altitude transitions to within 200 feet or 15 seconds of reaching the selected altitude (**Figure 4-23**). If an optional Sonalert tone generator device is installed, a one-second tone also sounds. Once the current altitude is within ± 25 feet of the Selected Altitude, the Altitude Alert extinguishes (**Figure 4-24**).

After reaching the Selected Altitude, if the aircraft's current altitude differs from the selected altitude by more than 200 feet, the yellow alert flag flashes. If an optional Sonalert tone generator device is installed, a one-second tone also sounds.

NOTE

Setting the Altitude Alerter provides visual and aural cues to help the pilot capture and maintain target altitudes. When set to a new altitude, the Alerter will illuminate a yellow flag adjacent to the target altitude display and sound a one-second tone; 15 seconds (or 200 feet) before the aircraft will reach the target altitude (based on current rate of climb or descent). The yellow flag will extinguish once the target is reached. Subsequently, if the aircraft deviates more than 200 feet above or below the target altitude, the flag will again illuminate, and another one-second tone will sound to alert the pilot to the deviation.

4.2.3.4. MINIMUMS Annunciation¹

The Pro PFD provides an adjustable MINIMUMS field to enhance situational awareness during instrument approaches. The Pro PFD provides a MINIMUMS annunciation with a series of markers on the Altitude Tape that provide the pilot with improved awareness when approaching and operating at minimums. There are three different color markers that are shown on the altitude tape that are associated with the MINIMUMS Annunciation, as described in **Table 4-1**.



Marker Color	Description	
Green	The aircraft is 500 feet above selected MINIMUM.	 <p>Figure 4-25 Minimums Green Triangle</p>
Hollow Yellow	The aircraft is 100 feet to 200 feet above the selected MINIMUM. The marker base is at 100 feet above MINIMUM, and the tip is at 200 feet above MINIMUM.	 <p>Figure 4-26 Minimums Hollow Yellow Triangle</p>
Red and Yellow stripes	The aircraft is at the selected MINIMUM.	 <p>Figure 4-27 Minimums Red/Yellow Striped Triangle</p>

Table 4-1
Selected MINIMUMS Markers

1. Not available with the Pilot PFD



Figure 4-28
MIN Hot Key – Selected MINIMUMS
Annunciation and Markers Disabled



Figure 4-29
Selected MINIMUMS
Annunciation and Markers
Enabled

Once the Selected Minimums field value is set to a Decision Altitude, Decision Height, or Minimum Descent Altitude, the Pro PFD provides an alert when the aircraft descends below this altitude. To activate this feature, enable the Selected Minimums (MIN) field and set the value with the Right Knob.

Display/Hide Minimums

1. Press the MIN Hot Key to alternately hide or display the Selected Minimums Field, MINIMUMS Annunciation, and Markers (**Figures 4-28 and 4-29**).

The range for the MIN data field is 0 – 15,000 feet, in increments of 10 feet. SYNCing sets the Selected Minimums field value to the current altitude (**Section 2.2.1.3**). The default value is 100 feet, or the previously set value.

NOTE

Pressing the MIN Hot Key presents the MINIMUMS Markers on the Altitude Tape and the Selected Minimums Field on the Attitude Display. The MIN label above the Right Knob and the MIN field value are rendered in magenta for editing.

Set Altitude Minimum

1. Press the MIN Hot Key to set the altitude minimum.

The Selected MINIMUMS Field and the MIN label above the Right Knob are rendered in magenta (**Figure 4-30**).

2. Rotate the Right Knob to change the value of the Selected MINIMUMS Field.

Once the correct value is selected, and after 10 seconds of inaction, the field is disabled (**Figure 4-31**).

Whenever the aircraft is at or below the Selected MINIMUMS setting, the MIN legend in the Selected Minimums Field turns inverse amber (**Figure 4-32**) and when configured with an optional Sonalert, a one-second stuttered tone is generated.

The inverse amber MIN Annunciation is cancelled when the aircraft is 100 feet above the selected minimums setting or when the selected minimums is set to a new altitude. Additionally, the MINIMUMS Markers on the Altitude Tape provide the pilot with additional awareness of aircraft altitude with respect to the set MINIMUMS.



Figure 4-30
Selected MINIMUMS Field -
MIN Enabled

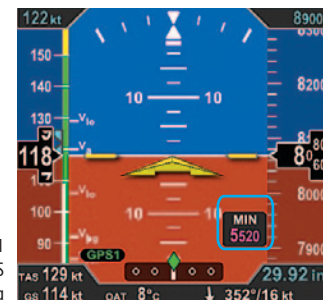

Figure 4-31
New Selected MINIMUMS
Annunciation Setting



Figure 4-32
MINIMUMS
Annunciation Active

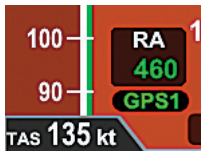

Figure 4-32a
Radio Altitude

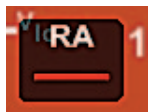

Figure 4-32b
Radio Altitude with
red slash

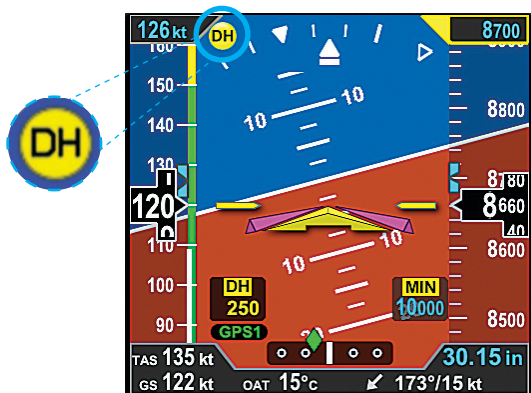

Figure 4-33
DH Annunciation

NOTE

“RAD ALT: DISABLE” Menu Key label is shown in gray if a compatible radio altimeter is not installed.

4.2.3.5. Radio Altitude Display¹

When a compatible radio altimeter is connected to the Evolution Display, radio altitude height in feet above ground level (AGL) can be displayed at the bottom left of the Attitude Display **Figure 4-32a**. When the aircraft is above the maximum range of the radio altimeter, the Radio Altimeter display window is removed. The maximum displayed altitude value will depend on the range of the radar altimeter equipment installed in the aircraft.

Radio Altitudes that are greater than or equal to 500 feet AGL are displayed in 100 foot increments (RA 500, RA 600, RA 700...) and altitudes less than 500 feet AGL are displayed in 10 foot increments (RA 490, RA 480, RA 470...)

The digital readout in the Radio Altitude (RA) window is normally displayed in green, however, when the aircraft is at or below the Decision Height (DH) set on the onboard radio altimeter's indicator (if applicable), the RA window on the PFD will show the DH legend as inverse amber and the current RA readout in amber. An amber DH (Decision Height) annunciation is also displayed near the upper left corner of the Attitude Display (**Figure 4-33**).

If the PFD detects a malfunction on the onboard radio altimeter, the RA window is displayed with a red slash through the digital readout **Figure 4-32b**.

Enable or Disable the Radio Altitude Display

1. Press the MENU Button and rotate the Right Knob to the GENERAL SETTINGS A page.
2. Press the RAD ALT Menu Key and rotate the Right Knob to toggle between ENABLE or DISABLE.
3. Press the MENU Button to exit.

¹ Not available with the Pilot PFD

4.2.3.6. Altitude Display

In some configurations, such as a stand-alone PFD, the altitude tape can be turned off, at the pilot's discretion, to facilitate screen declutter. Both Airspeed and Altitude tapes are affected by this action.

Hide/Display Airspeed and Altitude Tape

1. Press the MENU Button.
2. Rotate the Right Knob counterclockwise until GENERAL SETTINGS A page displays (**Figure 4-34**).
3. Press the TPS Menu Key.

The Menu label turns magenta, and the EDIT VALUE label displays above the Right Knob.

4. Rotate the Right Knob to the desired value, ENABLE (On) or DISABLE (Off) (**Figure 4-35**).
5. Press the MENU Button to exit.



Figure 4-34

Editing Airspeed and Altitude Tape Display



Figure 4-35

Airspeed and Altitude Tape Disabled

NOTE

A typical PFD only installation sets the tapes display to UNLOCKED, allowing the pilot to display or hide the Airspeed and Altitude tapes as desired. If the Airspeed and Altitude Tapes were LOCKED ON during installation, such as the case with a PFD and MFD configuration, then the tapes must remain on. If the Airspeed and Altitude Tapes were LOCKED OFF during installation, the tapes will not display.

NOTE

When the Altitude tape is disabled, the numerical display of the selected altitude and altitude minimums remain on. However, an installer can disable and remove the Selected Altitude and Minimums Fields, and the MINIMUMS Annunciation and Markers from the display.

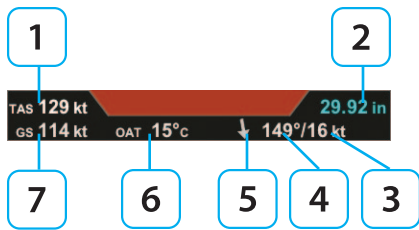

Figure 4-36
Data Bar

NOTE

If the OAT was set to disabled during installation, as would be the case if the RSM is mounted internally to the aircraft structure, then the OAT, TAS, and Wind Speed and Direction are not displayed.

4.3. Data Bar

The Data Bar presents True Airspeed (TAS) or the Mach number, GPS Ground Speed (GS), Outside Air Temperature (OAT), Wind Direction, Wind Speed, and Barometric Pressure Setting, as shown in **Figure 4-36**. The Data Bar is always present on the display. Invalid or out-of-range Data Bar values are dashed.

- | | |
|--|--|
| 1 True Airspeed (TAS) or MACH | 5 Wind Direction Arrow |
| 2 Barometric Pressure Setting Field | 6 Outside Air Temperature (OAT) |
| 3 Wind Speed | 7 Ground Speed (GS) |
| 4 Wind Direction | |

4.3.1. True Airspeed or Mach Number (when enabled)

The True Airspeed (TAS) or the Mach number is displayed in the upper left of the Data Bar. The TAS has a range of 20–999 knots or mph, using the same unit of measurement as the aircraft’s Airspeed Indicator. The TAS is a correction of the IAS for nonstandard pressure and temperature.

The Mach number can be configured to be displayed whenever the aircraft is above a selected altitude or above a selected Mach number and is shown with a display resolution of 0.01 Mach.

Select the Transition Setting

1. Press the MENU Button and rotate the Right Knob to the GENERAL SETTINGS C page.
2. Press the MACH DSPL Hot Key and rotate the Right Knob to the desired Altitude or Speed setting.
3. Press the MENU Button to exit.

4.3.2. Ground Speed

The Ground Speed (GS) comes from a configured GPS navigator and is digitally displayed in the lower left corner of the Data Bar with a value range of 5–999 knots or mph, using the same unit of measurement as the Airspeed Indicator.

4.3.3. Outside Air Temperature (when enabled)

The Outside Air Temperature (OAT) is displayed in the center of the Data Bar (**Figure 4-36**). The temperature is obtained from the temperature sensor located in the RSM. Temperature sensor ranges from -55°C to +80°C (-67°F to +176°F).

Set OAT Units of Measure

1. Press the MENU Button.
2. Rotate the Right Knob counterclockwise until GENERAL SETTINGS B page displays.
3. Press the OAT Menu Key.

The Menu label turns magenta and the EDIT VALUE label displays above the Right Knob (**Figure 4-37**).

4. Rotate the Right Knob to select either °C or °F (**Figure 4-37**).
5. Press the MENU Button to exit.



Figure 4-37
Select OAT Units of Measure



Figure 4-38
Wind Direction Arrow

NOTE

The wind computations require a GPS-provided ground track and ground speed to compute the wind direction and speed. If a GPS is not connected to the PFD or the data are invalid, the wind direction and speed are dashed and the wind direction arrow is removed.

4.3.4. Wind Speed, Direction, and Arrow (when enabled)

The Wind Speed, Direction, and Direction Arrow are displayed in the lower right portion of the Data Bar. The Wind Speed has a range of 10–999 knots or mph, using the same unit of measure as the Airspeed Indicator.

The Wind Direction and Arrow (**Figure 4-38**) have a range of 001°–360°, using the same direction reference used by the Direction Indicator. The arrow points in the direction of the wind and is displayed relative to the current direction of flight. For example, if the current direction of flight is 360° and the wind is from 360°, the arrow will point straight down on the display (a headwind blowing toward your aircraft).

When the computed wind speed is below 10 knots or mph (depending on aircraft configuration) the wind speed and direction values are blank, and the wind arrow is removed. If the wind data is out of range or invalid, the values are dashed, and the wind arrow is removed.

4.3.5. Barometric Pressure Setting Display

The Barometric Pressure Setting Field is displayed on the upper right corner of the Data Bar and is pilot-adjustable, as discussed in **Section 4.2.3.1**. When the Altitude Tape is disabled, the Barometric Pressure Setting field remains visible. However, an installer can disable the field and remove it from the display. **Section 4.2.3.1** provides complete information and step-by-step instructions for setting the barometric pressure.

4.4. Navigation Display

The Horizontal Situation Indicator (HSI) on the Navigation Display of the PFD, combines a Direction Indicator with a Course Deviation Indicator (CDI) (**Figure 4-39**).

The Direction Indicator comprises a compass, numerical direction indication, heading bug, Ground Track Marker (when GPS ground track information is available), rate of turn indicator, and aircraft ownership symbol. The CDI is comprises a selected course pointer, Deviation Scale and indicator, TO/FROM indicators, and selected navigation source label and information block.

- | | | | |
|----------|------------------------|-----------|--------------------------------|
| 1 | CDI Source Info Block | 8 | Aircraft Ownership Symbol |
| 2 | Magnetic Heading | 9 | Heading Bug |
| 3 | Rate of Turn Indicator | 10 | Selected CDI Navigation Source |
| 4 | Selected Heading Field | 11 | Course Deviation Scale |
| 5 | Ground Track Marker | 12 | Compass Scale |
| 6 | Course Pointer | 13 | Course Deviation Indicator |
| 7 | TO/FROM Indicator | | |

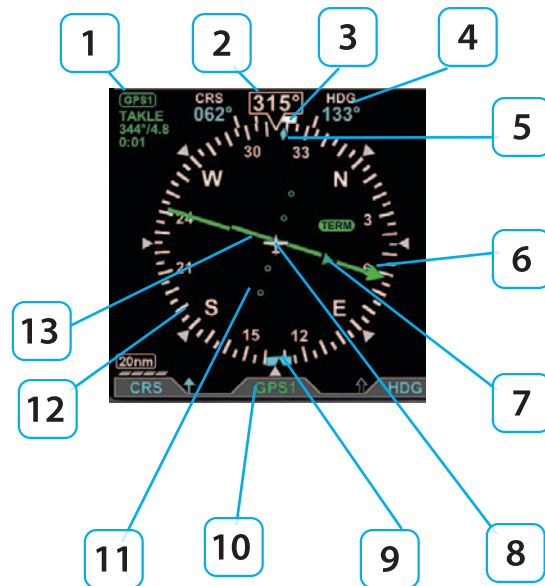

Figure 4-39
Horizontal Situation Indicator

NOTE

The size, shape and location of the Course Pointer, Deviation Scale, and Deviation Indicator depend on the Compass Mode selected..



Figure 4-40
360° Compass Mode



Figure 4-41
ARC HSI Compass Mode

All Magnetic Headings are displayed in degrees. The value range is from 001° - 360°, always displayed in three digits, and use leading zeros when applicable. The Magnetic North is expressed as 360°.

4.4.1. Compass

The PFD offers three Compass Modes: 360°, ARC HSI, and ARC CDI. The default Compass Mode is 360. The aircraft's heading is always expressed degrees magnetic. The magnetic headings inside of the compass scale omit the last zero for brevity (i.e., 30°, 60°, 120°, 150°, 210°, 240°, 300°, and 330° are labeled 3, 6, 12, 15, 21, 24, 30, and 33, respectively). The four cardinal compass headings are shown as letters (i.e., N for 360°, E for 090°, S for 180°, and W for 270°).

4.4.1.1. 360° Compass Mode

The 360° Compass Mode displays a full 360° compass rose with all other components of the Direction Indicator. The 360° compass rose rotation centers on the aircraft ownship symbol so that the numerical direction indication corresponds to the current aircraft heading (**Figure 4-40**).

4.4.1.2. ARC Compass Mode

The two ARC Compass Modes have an abbreviated 100° ARC compass scale. All other elements of the Direction Indicator are retained. The ARC Compass Mode's scale rotation centers on the aircraft ownship symbol so that the numerical direction indication corresponds to the current aircraft heading. The default ARC Compass Mode is ARC HSI.

The ARC HSI Compass Mode presents a rotating CDI, similar to that used in the 360° Compass Mode (**Figure 4-41**).

The ARC CDI Compass Mode uses a fixed CDI, resembling a contemporary GPS navigation deviation display. The ARC CDI Compass Mode is intended to maximize the lower display area for map and flight plan data (**Figure 4-42**).

Select ARC CDI/HSI Compass Mode

1. Press the MENU Button.
2. Rotate the Right Knob to the GENERAL SETTINGS A Menu page (**Figure 4-43**).
3. Press the ARC MODE Menu Key. The Menu label turns magenta, and the EDIT VALUE label displays above the Right Knob (**Figure 4-44**).
4. Rotate the Right Knob to select either HSI or CDI (**Figure 4-45**).
5. Press the MENU Button to exit.



Figure 4-44
Changing the ARC Compass MODE



Figure 4-42
ARC CDI Compass Mode



Figure 4-43
GENERAL SETTINGS A



Figure 4-45
ARC CDI Compass MODE Selected



Figure 4-46
360/ARC Hot Key

Select Compass Type

1. Press the 360/ARC Hot Key (**Figure 4-46**) to alternately select either the 360° or ARC Compass Mode.

The Navigation Display changes and the Hot Key label reflects the currently selected Compass Mode (**Figures 4-47 and 4-48**).



Figure 4-47
ARC CDI Compass Mode



Figure 4-48
360° Compass Mode

4.4.2. Course Pointer¹

For all Compass Modes, the arrowhead of the Course Pointer aligns with the corresponding value on the compass scale regardless of the aircraft heading. The ARC Compass HSI and CDI Course Pointers are different and are described in **Table 4-2**.

COMPASS	DESCRIPTION
ARC HSI	The Course Pointer length shortens as necessary when rotated to remain within the display area (Figure 4-49).
ARC CDI	The Course Pointer is shown as a stub arrow or tail whenever the CRS value or its reciprocal falls within the displayable range of the compass scale arc (Figure 4-50 and 4-51).

Table 4-2
ARC Compass Mode Course Pointer Display



Figure 4-49
Reduced Length Course Pointer,
ARC HSI Compass Mode



Figure 4-50
Stub Course Arrowhead,
ARC CDI Compass Mode



Figure 4-51
Stub Course Tail,
ARC CDI Compass Mode

1. Not available with the Pilot PFD

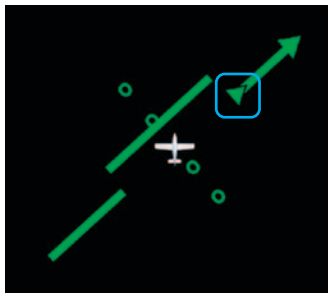

Figure 4-52
360° TO Indication

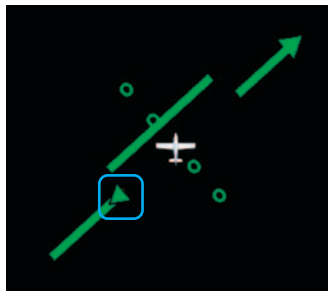

Figure 4-53
360° FROM Indication



Figure 4-54
HSI TO Indication



Figure 4-55
HSI FROM Indication

4.4.3. TO/FROM Indicator¹

Each of the Compass Modes has a TO/FROM indicator. The TO/FROM indicator shows whether the aircraft is heading toward a waypoint or radio navaid, or from a waypoint or radio navaid. For each Compass Mode, the TO/FROM indication is slightly different, as described in **Table 4-3**.

COMPASS	DESCRIPTION
360°	The TO indicator is an arrowhead on the top half of the Course Pointer, oriented in the same direction as the course arrowhead (Figure 4-52). The FROM indicator is an arrowhead on the bottom half of the Course Pointer, oriented in the direction opposite to the course arrowhead (Figure 4-53).
ARC HSI	The TO indicator is shown as two arrowheads, one on each half of the Course Pointer, oriented in the same direction as the course arrowhead (Figure 4-54). The FROM indicator is shown as two arrowheads, one on each half of the Course Pointer, oriented opposite to the direction of the course arrowhead (Figure 4-55).
ARC CDI	The TO indication is shown as TO on the left side of the Deviation Scale (Figure 4-56). The FROM indication is shown as FROM on the right of the Deviation Scale (Figure 4-57).

Table 4-3
TO/FROM Indicator Description



Figure 4-56
CDI TO Indication



Figure 4-57
CDI FROM Indication

1. Not available with the Pilot PFD

4.4.4. Course Deviation Indicator and Scale¹

Selected course deviation is depicted by a Course Deviation Indicator and Scale. Deviation is indicated by positioning the Course Deviation Indicator on the Scale corresponding to the lateral deviation value.

The 360° and ARC HSI Compass Modes show the CDI as a green line centered on the display and parallel with the Course Pointer. The scale is a set of four hollow, green dots that are perpendicular to the Course Pointer (**Figure 4-58**).

1 Course Deviation Indicator

2 Course Deviation Scale

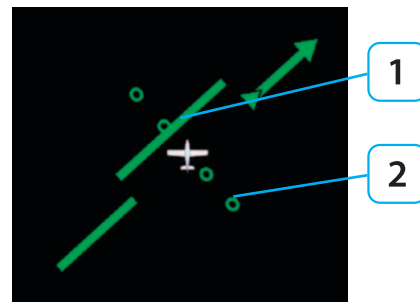

Figure 4-58
Deviation Indicator, 360° and
ARC HSI Compass Modes

The ARC CDI Compass Mode's CDI and Scale are located at the bottom of the lower display. The indicator is a green diamond, and the Scale is a set of four hollow, white dots with a white index mark at the center (**Figure 4-59**). When in the ARC CDI Compass Mode, on a Localizer Back Course approach, a BC label is presented to the left of the scale, and the Indicator corrects for reverse sensing (**Figure 4-60**).

When the lateral deviation exceeds the maximum displayable range of 2.5 dots, the Deviation Indicator bar or diamond, as applicable, becomes hollow and darker (**Figure 4-61** and **4-62**).



Figure 4-59
Course Deviation Indicator, ARC CDI
Compass Mode



Figure 4-60
Course Deviation Indicator, ARC CDI
Compass Mode with Back Course



Figure 4-62
Deviation Exceeded, ARC CDI

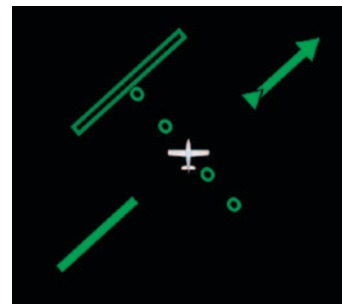

Figure 4-61
Exceeded Deviation, 360° and
ARC HSI Compass Modes

1. Not available with the Pilot PFD



Figure 4-62a
Back Course (BC) Annunciation Locations

4.4.4.a. Localizer Back Course (BC) Operation¹

When flying a Back Course final approach (the aircraft heading is opposite to the localizer front course), set the CRS value to the front course localizer or ILS approach value. The tail of the CDI will match the back course runway's magnetic orientation.

When the LOC(BC) mode is active, two "BC" annunciations are shown; on the Attitude Display left of the Lateral Deviation Indicator (LDI) and on the ARC Compass left of the Course Deviation Scale (**Figure 4-62a**). The left/right deviation indications are corrected for reverse sensing and will behave intuitively, the same as with a front course localizer.

4.4.5. CDI Navigation Source¹

When the PFD powers up, the default Selected CDI Navigation Source is the last source selected. The pilot can select from any of the installed navigation sources using the Lower Center Button. The PFD supports navigation information display from VHF Omnidirectional Radio Range (VOR) nav aids, Localizers (LOC), Glide Slope receivers (GS), and Global Positioning Systems (GPS). There can be up to four dedicated, two integrated, or a combination of one integrated and two dedicated navigation systems installed.

When individual GPS and VLOC devices are installed, the GPSS signal source, Basemap GPS position, flight plan, and Basemap information for VLOC1, VLOC2, and GPS1 are provided by the GPS1 navigation source whenever GPS1 is selected as the CDI navigation source and by GPS2 whenever GPS2 is selected as the Selected CDI navigation source.

When integrated GPS/VLOC equipment are installed, the GPSS signal source, Basemap GPS position, flight plan and Basemap information for the integrated GPS-VLOC is provided by the associated GPS whenever the CDI navigation source is selected to either the GPS side or the VLOC side of the integrated GPS/VLOC receiver.

¹ Not available with the Pilot PFD

Select the CDI Navigation Source

- Press the CDI Navigation Source Select button until the desired navigation source is displayed above the button (e.g., GPS1, GPS2, VLOC1, VLOC2) (Figure 4-63).

1

CDI Navigation Source Select Button

2

Selected CDI Source Label

3

CDI Source Information Block



Figure 4-63
CDI Source selection and Information

NOTE

For integrated systems, the CDI navigation source label indicates the current operating mode (GPS or VLOC) of the GPS/VHF NAV system.

When an integrated system is selected but not reporting its operating mode, VLOC1 or VLOC2 is shown as the Selected CDI Navigation Source.

Refer to the GPS or VHF NAV AFMS for information on the operation of the connected navigation equipment.

NOTE

When the PFD is connected to some GPS and the active flight plan is changed (e.g. "Direct To" is selected), the display of the active (magenta) leg on the Nav Map may be delayed for up to 20 seconds. The Course Pointer and autopilot will react immediately to the flight plan change.

NOTE

There are many radio configurations available. Your authorized Aspen Avionics Dealer can explain the configuration used on your aircraft.

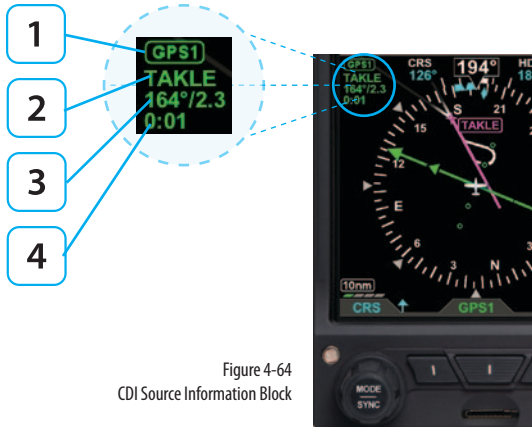

Figure 4-64
CDI Source Information Block

Whenever the CDI Navigation Source's data is valid, a CDI Source Information Block for the selected source is shown in the upper left corner of the Navigation Display, as shown in **Figure 4-64** and described in **Table 4-4**.

Radio Mode	Information Block Label	
GPS		GPS1 or GPS2
VHF	VOR	VOR1 or VOR2
	Localizer	LOC1 or LOC2
	Localizer Back	LOC1 (BC) or LOC2 (BC)
	ILS	ILS1 or ILS2

Table 4-4
VHF NAV Radio Modes

- 1 Selected CDI Navigation Source
- 2 Waypoint identifier or tuned frequency (when available)
- 3 Bearing (in degrees)/Distance (in Nautical Miles) to waypoint or navaid (when available)
- 4 Estimated Time Enroute (Hours:Minutes)

If both the station identifier and the tuned frequency of the associated VHF NAV radio are available, only the station identifier is displayed on the second line of the information block. In most cases, however, only the tuned frequency is available for display from integrated GPS/VLOC devices.

When available, the bearing and distance to station is displayed on the third line of the information block in the format ddd°/nnnn or ddd°/nn.n, where ddd is the bearing in degrees and nnnn or nn.n is the distance in nautical miles (e.g., 360°/1103 or 322°/3.2, shown in **Figure 4-64**). The distance to waypoint is displayed as follows:

- Distance to waypoint < 100 NM, display is in tenths of a mile, i.e., ##.#.
- Distance to waypoint is 100–9999 NM, display in whole miles, i.e., ####.
- Distance to waypoint is > 9999 NM, display is dashed, i.e., ----.

When available, the estimated time enroute information is displayed on the fourth line of the information block in the format h:mm (where h is hours and mm is minutes).

When CDI Navigation Source data is invalid or unavailable from a configured navigation source, the HSI course deviation bar and the TO/FROM indicator are removed from the display (**Figure 4-65**). Additionally, the selected CDI Navigation Source label in the CDI Source Information Block is slashed with a red line (**Figure 4-66**).

When information for a configured and selected navigation source is unavailable or is invalid, the CDI Source Information Block is blank (**Figure 4-67**).



Figure 4-65
No Course Deviation Bar or TO/FROM Indicator



Figure 4-66
Invalid CDI Navigation Source Label



Figure 4-67
CDI Source Information Blank Block



Figure 4-68
Menu, GENERAL SETTINGS



Figure 4-69
Editing AUTO CRS



Figure 4-70
AUTO CRS Enabled

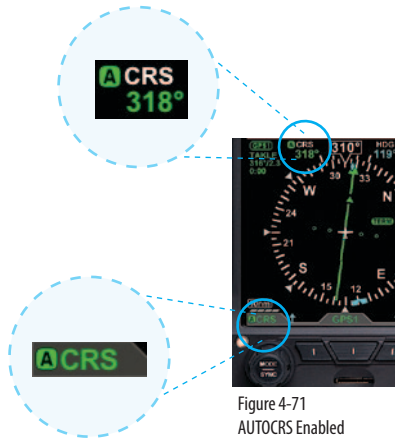

Figure 4-71
AUTO CRS Enabled

4.4.6. Auto Course¹

The pilot can either use the Auto Course (AUTO CRS) or manually set a CRS value. By default, AUTO CRS is enabled. When the selected CDI Navigation Source is a connected GPS receiver and AUTO CRS is enabled, CRS is not adjustable (current course value is automatically slewed and controlled by the desired track from the GPS). When AUTO CRS is enabled, the CDI navigation source is a GPS, and that system is configured for automatic waypoint sequencing (i.e., not OBS or HOLD modes) then Auto Course Select is active.

Enable Auto Course

1. Press the MENU Button.
2. Rotate the Right Knob to the GENERAL SETTINGS A page (**Figure 4-68**).
3. Press the AUTO CRS Menu Key.

The Menu label turns magenta, and the EDIT VALUE label displays above the Right Knob (**Figure 4-69**).

4. Rotate the Right Knob to select ENABLE (**Figure 4-70**).
5. Press the MENU Button to exit.

When AUTO CRS is enabled, the CRS value is set to the desired track output from the CDI Navigation Source. The CRS value is shown in the upper left of the lower display area in green under the CRS label. Additionally, an inverse green A is shown beside the CRS label in the upper left of the lower display area and in the legend above the Left Knob. This indicates that the course is being automatically adjusted (**Figure 4-71**).

1. Not available with the Pilot PFD

Disable Auto Course

1. Press the MENU Button.
2. Rotate the Right Knob to the GENERAL SETTINGS A page (**Figure 4-72**).
3. Press the AUTOCRS Menu Key.

The Menu label turns magenta, and the EDIT VALUE label displays above the Right Knob (**Figure 4-73**).

4. Rotate the Right Knob to select DISABLE (**Figure 4-74**).
5. Press the MENU Button to exit.

4.4.7. CDI Selected Course¹

When the CDI source changes from a GPS source with AUTOCRS to another CDI source, the CRS value reverts to the last set value. When the CDI source is set to a VHF receiver operating in the VOR or Localizer modes, editing the CRS value adjusts the current selected CRS value. When the CDI source is set to a GPS receiver, and AUTOCRS is disabled, the CRS value may be adjusted.

Select CDI Course

1. Press the Left Knob.

The CRS label above the Left Knob and the Course field are enabled for editing, both rendered in magenta (**Figure 4-75**).

2. Rotate the Left Knob to change the value of the Course field.

Once the CRS value is set, and after 10 seconds of inaction, the CRS field is disabled, and both the label and field are rendered in cyan.



Figure 4-72
Menu, GENERAL SETTINGS



Figure 4-73
Editing AUTOCRS



Figure 4-74
AUTOCRS Disabled



Figure 4-75
CRS Field Enabled for Editing

1. Not available with the Pilot PFD



Figure 4-76
Bearing Pointer Description

NOTE

Distance to waypoint < 100 NM, display is in tenths of a mile, i.e., ##.#.

Distance to waypoint is 100 – 9999 NM, display in whole miles, i.e., ####.

Distance to waypoint is > 9999 NM, display is dashed, i.e., ----.

4.4.8. Bearing Pointer Source Selection¹

When the 360° Compass mode is selected, single- and double-line bearing pointers are available (**Figure 4-76**). The bearing pointers are independent of the CDI and provide supplemental navigation information by pointing to active GPS waypoints or nav aids. By default, the bearing pointers are off and not displayed.

1	Single-Line Bearing Pointer	
	Single-Line Bearing Pointer Source Information	
2	Top Line	Distance (NM) to active GPS waypoint
	Bottom Line	Waypoint identifier, station identifier (when available, or the tuned frequency of the associated VHF NAV radio (when available)
3	Single-Line Bearing Pointer Icon	
4	Double-Line Bearing Pointer	
	Double-Line Bearing Pointer Source Information	
5	Top Line	Distance (NM) to active GPS waypoint
	Bottom Line	Waypoint identifier, station identifier (when available), or the tuned frequency of the associated VHF NAV radio (when available)
6	Double-Line Bearing Pointer Source	

1. Not available with the Pilot PFD

The Bearing Pointers indicate only the bearing information provided by their selected navigation sources. They resemble and perform like traditional Radio Magnetic Indicator (RMI) needles. Each Bearing Pointer's head and tail is aligned with the corresponding bearing/radial value on the compass. The pilot can select a navigation source for each of the Bearing Pointers from the same VOR and GPS sources available to the CDI or simply turn off the Bearing Pointer and Source Information.

Each Bearing Pointer is associated with a Lower Left Button or a Lower Right Button, its source, and Information Block. The Lower Left Button, immediately adjacent to the CDI Navigation Source Selection Button is associated with and controls the Single-Line Bearing Pointer. Likewise, the Lower Right Button controls the Double-Line Bearing Pointer. The Bearing Pointers' Source Information is shown directly above their respective Buttons.

Unlike the CDI's Course Pointer, which can be adjusted by the pilot, no adjustments can be made to the Bearing Pointers. When a VOR is selected as the source, the arrow of the needle points to the VOR navaid to which the receiver is tuned. The position of the Bearing Pointer tail, with respect to the compass, indicates the aircraft's current position on the VOR radial. When a GPS source is selected, the Bearing Pointer indicates the bearing to the active waypoint.

When the Bearing Pointer Source Information is unavailable or invalid, the Bearing Pointer and its Source Information are removed (**Figure 4-77**). The Bearing Pointer's Source is also source legend slashed with a red line (**Figure 4-78**).

When a Bearing Pointer is turned OFF, only the Bearing Pointer's icon is shown. The Selected Source, the Source Information, and the Bearing Pointer are removed (**Figure 4-79**).



Figure 4-77
Bearing Pointers Off



Figure 4-78
Invalid Bearing Pointer Source



Figure 4-79
Icons when Bearing Pointers are Off

NOTE

A VOR that is tuned to a localizer frequency is considered an invalid Bearing Pointer source since Localizer signals provide no bearing information.

Select the Single-Line Bearing Pointer Source

1. Press the Single-Line Bearing Pointer Button (Lower Left Button, **Figure 4-80**) until the desired navigation source is shown above the Button.

Select the Double-Line Bearing Pointer Source

1. Press the Double-Line Bearing Pointer Button (Lower Right Button, **Figure 4-81**) until the desired navigation source is shown above the Button.



Figure 4-80
Single-Line Bearing Pointer and Button



Figure 4-81
Double-Line Bearing Pointer and Button

4.4.9. Heading Bug

The PFD offers a pilot-selectable Heading Bug. The Heading Bug symbol is positioned on the compass scale according to the Selected Heading Field value (HDG) set by the pilot (**Figure 4-82**).

When the Selected HDG Field value is outside the visible compass scale range in the ARC Compass mode, only a portion of the Heading Bug is shown at the edge of the compass arc, closest to the HDG value (**Figure 4-83**).

When selected for editing, the Heading Bug and the Selected HDG Field value are shown in magenta. Additionally, a dashed magenta line extends from the Ownship Symbol to the Heading Bug, corresponding to the HDG value. When the Heading Bug is SYNCed, the HDG value is set to the current heading.

Set Heading Bug

1. Press the Right Knob.

The HDG label above the Right Knob and the Selected Heading Field are enabled for editing, both rendered in magenta (**Figure 4-84**).

2. Rotate the Right Knob to change the value of the Selected Heading Field.

Once the HDG value is set, and after 10 seconds of inaction, the Selected HDG Field is disabled, and both the Right Knob State and the Selected Heading Field are displayed in cyan.



Figure 4-82
Heading Bug and Selected
Heading Field



Figure 4-83
Selected Heading Bug Outside of
the ARC Compass Scale Range



Figure 4-84
Heading Selected to Edit



Figure 4-85
Direction of Flight
Numerical Display



Figure 4-86
Direction Indicator Fail



Figure 4-87
Rate of Turn Indicator
(360° Compass Mode)



Figure 4-88
Rate of Turn Indicator
(ARC Compass Mode)

4.4.10. Aircraft Heading Display

The aircraft heading is displayed in degrees magnetic (**Figure 4-85**).

If the aircraft's heading is unavailable or invalid, all heading and navigation information, including the CDI and bearing pointers (if previously displayed), is removed and replaced with a single red X covering the entire lower display area, along with the annunciation DIRECTION INDICATOR FAIL (**Figure 4-86**).

4.4.11. Rate of Turn Indicator

The Rate of Turn Indicator consists of a curved white line originating from the corresponding side of the aircraft heading (i.e., a left turn indication starts on the left side of the index mark) and extends in the direction of the turn along the outer radius of the compass scale. The turn rate indication is provided for every compass mode, 360° (**Figure 4-87**) and ARC (**Figure 4-88**).

The Rate of Turn Indicator features tick marks for full and half-standard rate turns (a standard rate turn = 3° per second).

The Rate of Turn Indicator has a range of 0° – 6° per second. When the turn rate exceeds 6° per second, an arrowhead is added to the end of the tape to show that the rate of turn has exceeded the limits of the instrument.

4.4.12. Basemap Overlays

The Basemap comprises symbols depicting the location of flight plan waypoints and legs, airports, VORs, DMEs, NDBs, and intersections. The Basemap is always oriented with magnetic heading up and centered so that the current aircraft position coincides with the aircraft's Ownship Symbol. The current Basemap declutter level and range are shown on the lower left side of the display (Figure 4-89).

- 1 Basemap Symbols
- 2 Aircraft Ownship Symbol
- 3 Basemap Declutter Level
- 4 Basemap Range

When enabled, the Basemap features on the Navigation Display are displayed and layered as detailed in Table 5-12. The GPS flight plan is rendered in either straight or curved lines, as supported by the configured GPS navigator. The displayed symbol set includes active waypoints, active flight plan leg, flight plan waypoints, flight plan legs, airports, VORs, VORTACs, TACANs, DMEs, intersections, and NDBs (Figure 4-90).

NOTE

All map and flight plan elements are received from the GPS and are only available from compatible GPS navigators (e.g. GNS 430/530).

NOTE

A VORTAC is shown as a combined VOR and DME symbol. A TACAN is rendered as a DME symbol.



Figure 4-89
Basemap (ARC CDI Compass Mode Shown)

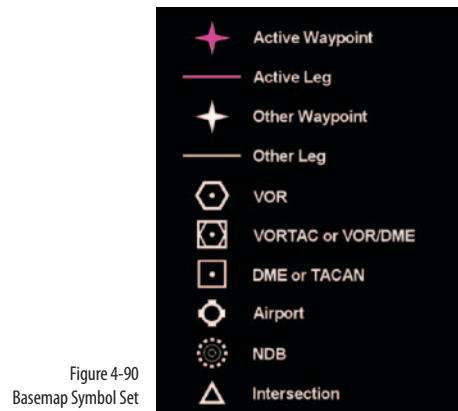

Figure 4-90
Basemap Symbol Set

Figure 4-91
MAP Hot KeyFigure 4-93
Basemap Range Buttons

NOTE

When connected to a GPS that does not provide compatible Basemap data, only OFF and FP ONLY declutter levels are available.

4.4.12.1. Basemap Declutter and Range

To turn the Basemap on or off, the pilot selects one of the declutter levels as described in **Section 5.2**. The default map declutter level is Level 4. The map range corresponds to the outside radius of the compass scale, 2, 3, 5, 10, 15, 20, 30, 40, 60, 80, 100, or 200 nautical miles from the aircraft Ownship Symbol. The default range is 15nm. Both the map declutter level and range are pilot-adjustable.

Select Map Declutter Level

1. Press the MENU Button and rotate the Right Knob to MAP SETTINGS page.
2. Press the DCLTR LVL Menu Key (**Figure 4-91**) and rotate the Right Knob to select the desired map declutter level.
3. Press the MENU Button to exit.

The new Basemap display level appears above the Left Knob (**Figure 4-92**).

Change Map Range

1. Press the Range Up (RNG +) or the Range Down (RNG -) Button (**Figure 4-93**), until the desired range is displayed (**Figure 4-94**).

Figure 4-92
New Basemap Display LevelFigure 4-94
New Basemap Range

The PFD has an Auto Range feature that automatically scales the range (to the closest range setting) to fit the Aircraft Ownship and the active waypoint within the Navigation Display, e.g., if the active waypoint is 84 miles away, Auto Range will select a 100nm range (the closest range setting is 100nm). When Auto Range is active, an inverse white A is shown next to the range value (**Figure 4-95**).

Enable Auto Range

1. Press the MENU Button.
2. Rotate the Right Knob to the GENERAL SETTINGS B Menu page.
3. Press the AUTO RNG Menu Key.

The AUTO RNG label turns magenta (**Figure 4-96**).

4. Rotate the Right Knob to the desired value, either ENABLE or DISABLE.
5. Press the MENU Button to exit.

Activate Auto Range

1. Press the RNG +/- button to select the highest or lowest map range.
2. Release and then press and hold the RNG +/- button for two seconds.

The map range changes and the new map range is indicated on the map. An inverse white A displays next to the numeric range value.

Deactivate Auto Range

1. Press the RNG +/- Button once to deactivate Auto Range mode.

The inverse white A next to the numeric range value is removed.

Pressing RNG + moves to the next higher range; pressing RNG - moves to the next lower range.



Figure 4-95
Auto Range Mode

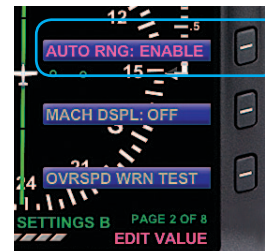

Figure 4-96
GENERAL SETTINGS B Page Editing
Auto Range Setting

NOTE

The map range increases or decreases one increment each time the RNG + or - Button is pressed. Press and hold to continuously increase or decrease the range.

NOTE

The Basemap declutter setting can determine what is displayed for a particular range. Refer to **Chapter 5, Table 5-9** for more information.



Figure 4-97
GPS1 Failure, Reversionary Navigation



Figure 4-98
RSM GPS Reversionary Navigation

Auto Range is only available when a flight plan is active. Since Auto Range uses the distance between the present position and the next active waypoint to compute the appropriate map range, if the currently Selected CDI Navigation Source does not have a valid flight plan, then Auto Range is not selectable. If Auto Range cannot be selected check:

- To ensure a flight plan is active
- The GPS source with the flight plan is the Selected CDI Navigation Source
- That Auto Range is enabled from the General Settings B Menu page

4.4.12.2. Flight Plan¹

When a flight plan is provided by a configured GPS, the map shows flight plan waypoints and legs. The active leg and waypoint and associated identifier are displayed in magenta. Other waypoints and legs are white. Straight and curved flight plan details are rotated within the map display to maintain their correct relative orientations at all times.

4.4.12.3. Map Data Source and Reversion¹

If the selected GPS data is unavailable or invalid:

- The associated flight plan and map data are retained and displayed, as long as an alternate source of position information remains available.
- The flight plan and waypoints become inactive and are displayed in white.
- Position is provided from:
 1. Another configured GPS source if providing valid position data. In this case, a GPS# REVERSION annunciation is shown above the Selected CDI Navigation Source (**Figure 4-97**) (# indicates the configured GPS source that is now providing the aircraft's position, either 1 or 2).
 2. The RSM GPS, if enabled, and position data are available. In this case, a RSM GPS REVERSION EMER USE ONLY annunciation is shown above the Selected CDI Navigation Source (**Figure 4-98**).

¹ Not available with the Pilot PFD

When a GPS source's position data are invalid or no longer available, an amber annunciation, GPS1, GPS2, or RSM GPS, is shown in the lower left corner of the Navigation Display to indicate which has failed (Figure 4-99).

4.4.13. Ground Track Marker¹

When configured with a GPS that provides ground track data, a Ground Track Marker is displayed on the compass scale to indicate the aircraft's ground track. This marker may be used to compensate for wind drift during flight (Figures 4-100 and 4-101). The Ground Track Marker is removed from the display when ground track data is not available or invalid.

4.4.14. GPS OBS Operation with a PFD and a Mechanical Standby Nav Indicator¹

When the PFD and a mechanical standby Nav indicator are both connected to an integrated VOR/Localizer/GPS Navigation system, the standby indicator and the PFD operate normally in all VOR, GPS and localizer modes.

When the GPS OBS mode is selected, the PFD Selected Course (CRS) control commands the GPS OBS course and the mechanical standby nav indicator's OBS course selector is ignored by the integrated navigation system. Deviation indications are shown on both displays. When the PFD is turned off, the course selector on the mechanical standby Nav indicator commands the GPS OBS value.

4.4.15. Course Pointer Operation with Integrated VOR/Localizer/GPS Navigation Systems¹

During manual or automatic operation of the integrated system, when transitioning from GPS guidance to VOR or localizer guidance, the course pointer on the should manually be set to the appropriate course.



Figure 4-99
Invalid or Failed GPS Annunciations



Figure 4-100
ARC Compass Mode, Ground Track Marker



Figure 4-101
360° Compass Mode, Ground Track Marker

1. Not available with the Pilot PFD



Figure 4-102
Lateral and Vertical Deviation Indicators
and Source Information

4.5. Lateral and Vertical Deviation Indicator¹

In addition to the CDI in the Navigation Display, separate displays of lateral and vertical deviation information are shown in the Attitude Display during instrument approaches. A Lateral Deviation Indicator (LDI) and a Vertical Deviation Indicator (VDI) (**Figure 4-102**) will automatically appear, depending on the operating mode of the selected navigation sensor and the validity of the associated signal, as described below.

1

Vertical Deviation Indicator (VDI)

2

Lateral Deviation Indicator (LDI)

3

LDI Navigation Source Annunciation

4.5.1. Lateral Deviation Indicator¹

The LDI and corresponding LDI Navigation Source Annunciation automatically display when:

- The active navigation source is a GPS radio, GPS is in the Approach mode, and the signal is valid.

Or

- The active navigation source is a VHF navigation radio and a valid LOC, LOC(BC), or ILS signal is received.

¹. Not available with the Pilot PFD

When the LOC(BC) mode is active, deviation indications (corrected for reverse sensing) are displayed. The deviation shown on the LDI directly corresponds to the deviation indicated on the CDI in the Navigation Display. When the lateral deviation exceeds the displayable range of 2.5 dots, the Course Deviation Diamond becomes dim and hollow, and is parked at the extreme edge of the LDI scale (**Figure 4-103**).

When the LDI navigation source is invalid or is no longer available, the Lateral Deviation Diamond is removed from view, and the Navigation Source Annunciation is slashed by a red horizontal line (**Figure 4-104**).

4.5.2. Vertical Deviation Indicator¹

The Vertical Deviation Indicator (VDI) is enabled and is shown on the Attitude Display when the active navigation source is a VHF navigation radio, the ILS mode is active, and a valid localizer signal is being received. The VDI is also displayed for a GPS, supplying valid vertical deviation data, when in the Approach mode.

The VDI will only display with a valid vertical guidance signal. When the vertical deviation exceeds the displayable range, the Glide Slope Deviation Diamond becomes dim and hollow, and is parked at the extreme edge of the VDI scale (**Figure 4-105**).



Figure 4-103
Lateral Deviation Diamond
Off Scale Indication



Figure 4-104
LDI Source Invalid



Figure 4-105
Vertical Deviation Diamond Off Scale Indication

1. Not available with the Pilot PFD



Figure 4-106
VSI



Figure 4-107
VSI Tape Off-Scale



Figure 4-108
VSI Fail – 360° Compass Mode

4.6. Vertical Speed Indicator

When the 360° Compass Mode is selected, the Vertical Speed Indicator (VSI) is rendered on the right side of the Navigation Display, showing a numerical and graphical representations of vertical speed. The VSI shows the change in pressure altitude over time. The graphical display is a white VSI Tape, with the numerical value at the top (**Figure 4-106**). In either ARC Compass mode, only the numerical value is shown.

The VSI Tape displays rates of $\pm 2,000$ FPM while the numerical value displays rates up to $\pm 9,990$ FPM. When the vertical speed exceeds $\pm 2,000$ FPM, a triangle caps the VSI Tape (**Figure 4-107**).

The VSI Tape is nonlinear, giving more display area to the 0 to $\pm 1,000$ FPM range than to the $\pm 1,000$ to $\pm 2,000$ FPM range. Tick marks are presented only in the direction of the climb or descent to provide visual cues for trends. The VSI's numerical value, tape, and scale are only shown if the aircraft is climbing or descending more than ± 100 FPM. During level flight in calm air conditions, the Tape, scale, and zero reference line are removed from the display. The numerical value is always enabled and shows dashes when vertical rates are out of range. If vertical speed is invalid, the Tape and numerical display are replaced with a red X and the annunciation, VSI FAIL (**Figure 4-108**).

4.7. Autopilot Integration¹

The Pro PFD can connect with many different legacy autopilot systems that are typically found in general aviation aircraft. The PFD emulates the HSI and/or Flight Director (FD) with which the autopilot was originally certified. Autopilot integration is limited to heading and navigation modes, including vertical approach modes.

When connected to an autopilot system that includes Nav or Approach couplers, the PFD also acts as the navigation source selector switch to the autopilot. This assures that the navigation information selected for the PFD is the same as that being provided to the autopilot. This arrangement also eliminates the need for external autopilot navigation source selector switches and relays that were previously used to select which navigation radio would be connected to the autopilot. Selection of autopilot modes and mode control is unaffected by the installation of the PFD.

The PFD does not currently provide vertical coupling to barometric references, such as altitude hold, vertical speed, or altitude capture.

See **Section 4.7.3. Typical Autopilot Operation** for more details on PFD operation with the autopilot systems during typical aircraft operations, such as VOR/ILS/GPS approaches.



Refer to the autopilot AFMS for information on the operation of the autopilot or Flight Director.

1. Not available with the Pilot PFD

 **WARNING**

GPS Steering is a powerful automation tool that can substantially reduce pilot workload. However, using GPSS safely and effectively requires a thorough understanding of your specific aircraft installation and the interaction between the PFD, your GPS navigator, and your autopilot. Pilot actions required to use GPSS safely can vary significantly depending on the autopilot and GPS navigator installed, especially when used on instrument approaches, especially those with vertical guidance.

It is imperative that pilots new to GPSS gain experience with it in VFR conditions and, ideally, get dual instruction from a CFII who thoroughly understands GPSS and the autopilot and GPS navigator in your airplane before using GPSS on instrument procedures in IMC.

4.7.1. GPS Steering (GPSS)¹

GPS Steering represents a modern approach to flying between flight plan waypoints, and offers many advantages of over traditional methods of flying direct course lines between waypoints.

With traditional point-to-point navigation, the autopilot is provided with desired course and cross-track deviation information associated with the current flight leg. From there, it will maneuver the aircraft to center the needle and track the desired course. The autopilot does not anticipate upcoming course changes, nor can it fly curved flight paths without pilot assistance, and it has to recompute wind corrections following each course change. Upon reaching a waypoint, the pilot must set the course for the next leg (unless AUTO CRS is enabled, see **Section 4.4.6. Auto Course**), and the autopilot will then intercept and track that leg. In this type of operation, the CDI must always be set to the desired course.

With GPSS, the PFD can unlock the GPS Steering capability already available in many models of general aviation GPS navigators. With GPSS, the navigator continuously computes the desired bank angle to track the GPS flight plan, and outputs that information over a digital data bus. The GPS Steering command anticipates upcoming turns; this includes the turn rate and turn initiation point required to roll out centered on the next leg.

Some GPS navigators, such as the Garmin 4xx/5xxW series of WAAS navigators, even provide GPS Steering commands for complex procedures, such as DME arcs, holding patterns, and procedure turns allowing the autopilot to fly these maneuvers without pilot intervention. Check with your GPS manufacturer to see if your GPS supports these capabilities.

1. Not available with the Pilot PFD

The PFD translates GPS Steering commands received over a digital data bus into a signal that is compatible with the autopilot Heading channel. Thus, by selecting GPSS on the PFD and the Heading mode of the autopilot, the autopilot is able to fly GPSS commands.

If the connected GPS does not provide the required steering commands, the GPSS legend adjacent to the GPSS Hot Key will be rendered in gray, and it will not be possible to enable GPSS with the Hot Key.

Enable/Disable GPSS

1. Press the GPSS Hot Key to alternately enable or disable GPS Steering (**Figure 4-109**).



Figure 4-109
GPSS Hot Key

NOTE

Refer to the Aircraft Flight Manual Supplement for your GPS for information about GPSS commands that may be output by that system.

NOTE

When GPSS is selected on the PFD, the autopilot must be in Heading mode to follow the GPSS commands.

NOTE

When GPSS is disabled, the autopilot will follow the Heading Bug.



Figure 4-110
GPSS Enabled with Autopilot in
HDG Mode



Figure 4-111
GPSS Disabled and Autopilot in
HDG Mode

When GPSS is enabled, and the autopilot is in HDG mode, the autopilot will follow the steering commands from the GPS. A GPSS enabled state will be indicated on the PFD in two locations: 1) the GPSS legend adjacent to the GPSS Hot Key will be shown in inverse green; and 2) the annunciation GPSS1 (or GPSS2, depending on the selected source), along with an inverse A, will be shown next to the HDG reference at the top of the Navigation Display, to the right of the Magnetic heading indication (**Figure 4-110**).

When GPSS is disabled, and the autopilot is in HDG mode, the autopilot will follow the PFD Heading Bug. A GPSS disabled state will be indicated on the PFD in two locations: 1) the GPSS legend adjacent to the GPSS Hot Key will be shown in gray; and 2) the Selected Heading Field will return. (**Figure 4-111**).

When the PFD Basemap navigation source is GPS1, enabling GPSS with the autopilot in HDG mode will cause the autopilot to track the flight plan in GPS1, and GPSS1 will be annunciated by the HDG reference at the top of the Navigation Display. Similarly, when GPS2 is the Basemap navigation source on the PFD, and GPSS is enabled, the autopilot in HDG mode will track the GPS2 flight plan, and GPSS2 will be annunciated at the top of the navigation display. See **Section 4.4.5** for additional information on the relationship among the CDI navigation source, Basemap navigation sources, and GPSS navigation source.

When using GPSS with a stand-alone VLOC receiver, or with a combined GPS/VLOC navigator (e.g., the GNS-430/530), GPSS will continue to follow the GPS output of that combined navigator, even when VLOC is selected as the PFD Selected CDI Navigation Source. With combined GPS/VLOC receivers, the transition from GPS to VLOC may occur automatically, depending on how that system has been configured by the pilot.

For example, suppose you use a GNS-430 to fly a GPS flight plan and have an ILS instrument approach loaded and active, and the GNS-430 is set for Auto ILS CDI changeover once you are established inbound on the final approach course. With GPSS enabled on the PFD and the autopilot in HDG mode, the GPSS will steer the autopilot laterally through the flight plan using GPS, even after the GNS-430 CDI automatically switches to VLOC, and the PFD navigation source similarly switches to VLOC. However, until you switch the autopilot into the Approach mode, it will not arm or capture the glideslope to fly the ILS approach. This feature is particularly useful for autopilots that do not automatically transition from Heading mode to Nav mode when the selected course is intercepted.

When flying an ILS on a WAAS GNS-430W, the autopilot in HDG mode can use the GPSS to fly the full course reversal automatically, and the GNS-430W will automatically switch to VLOC once established inbound to the Final Approach Fix. But the pilot must then engage the Approach mode on the autopilot to track the localizer and couple to the glideslope.

Several conditions can cause GPSS to be disabled automatically (switching to a different GPS steering source on the PFD, losing the GPS navigator source, canceling the flight plan, etc.). If this happens, the PFD will send a Wings Level command to the autopilot when in HDG mode, the GPSS Hot Key will annunciate the condition by showing GPSS in inverse amber, and the GPSS# and inverse A annunciation at the top of the Navigation Display will be shown with a red slash. (See **Figure 4-112**). To re-engage GPSS, select a valid GPS navigation source (with valid flight plan or direct-to selection on the GPS navigator), and then press the GPSS Hot Key. If a valid GPSS signal cannot be restored, pressing the GPSS Hot Key will cancel GPSS mode and restore the Heading Bug's output to the autopilot. More detail on these abnormal conditions, and corrective pilot actions, can be found in **Chapter 6, Expanded Emergency and Abnormal Procedures**. See also **Chapter 4, Section 4.7.3. Typical Autopilot Operations**.

 **NOTE**

Refer to the autopilot systems Aircraft Flight Manual Supplement and/or POH for details regarding use and operation of the autopilot system.

Examples here are provided for reference only, based on operation of the Bendix/King KFC-200 autopilot, and actual operation may vary depending on the autopilot system installed in your aircraft.

 **WARNING**

It is your responsibility as Pilot in Command to ensure that you are familiar with the operation of all installed equipment. Operation of the PFD in IMC conditions should not be attempted unless you are proficient in its use and operation, as described herein.



Figure 4-112
GPSS Automatically
Disabled — Wings Level Mode

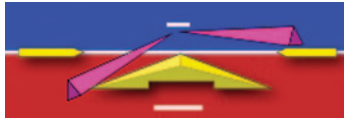

Figure 4-113
Flight Director

4.7.2. Flight Director¹

When connected to a compatible autopilot system, the PFD will display a single-cue Flight Director (FD). The FD's command bars visually represent the lateral and vertical steering cues transmitted to the PFD by the autopilot (**Figure 4-113**). When the FD output from the autopilot is unavailable or invalid, the FD command bars are removed from the display. To hand fly using the FD, maneuver the airplane to tuck the Aircraft Reference Symbol into the FD's command bars.

4.7.3. Typical Autopilot Operations¹

Whenever the PFD's installed configuration includes connections to GPS, VLOC, and autopilot systems, it acts as a data conduit between the navigators and the autopilot. This enables any compatible navigator to be coupled to the autopilot.

NOTE

With the autopilot in HDG mode, if GPSS is automatically disabled, the autopilot will roll wings level; it will not follow the Heading Bug.

1. Not available with the Pilot PFD

HDG Mode Operation – Heading Bug Steering

1. Set the PFD Heading Bug to the desired heading (**Section 4.4.9**).
2. Verify that GPSS is not selected.
3. Select the autopilot's Heading (HDG) mode.
4. Engage the autopilot and verify that the autopilot turns the aircraft to the selected heading.

HDG Mode Operation – GPS Steering (GPSS)

1. Couple the PFD CDI to a GPS navigation source with an active flight plan.
2. Enable GPSS by pressing the GPSS Hot Key.
3. Select the autopilot's Heading (HDG) mode.
4. Engage the autopilot and verify that the autopilot turns the aircraft to follow the GPS flight plan.

NAV Mode Operation – VLOC Navigation

1. Using the CDI Source Select button, couple a tuned/valid VLOC radio to the PFD CDI and adjust the Course Pointer (CRS) to a value that will intercept the course.
2. Set the PFD Heading Bug
3. Engage the autopilot in Heading (HDG) mode and verify that the aircraft turns to the desired heading.
4. If your autopilot supports automatic Heading to Navigation mode transitions, arm Navigation capture on the autopilot by selecting its Navigation (NAV) mode. Otherwise, select the autopilot's Navigation (NAV) mode when the autopilot's navigation signal capture criteria are satisfied (see your autopilot AFMS for more information).
5. Monitor the PFD CDI deflection and verify that, upon intercepting the desired course, the autopilot modes transition appropriately and the autopilot tracks the desired course.

NOTE

When GPSS is enabled, the HSI Heading Bug is not coupled to the autopilot. To connect the Heading Bug to the autopilot, disable GPSS with the GPSS Hot Key.

NOTE

The autopilot must be in Heading (HDG) Mode to receive GPSS signals from the PFD.

NOTE

*When using an integrated GPS/VLOC navigator, select VLOC or GPS with the CDI source button on the GPS select until the desired CDI Navigation Source is shown on the PFD (See **Section 4.4.5**.)*

 **NOTE**

Not all autopilots operate in the manner described here for intercepting courses. See the AFMS for your autopilot installation to understand how to adapt these example procedures to your particular autopilot.

 **NOTE**

In order for the autopilot to couple to vertical guidance on GPS WAAS approaches, most autopilots must first be established on the final approach course and in the Altitude (ALT) Hold mode at least two miles outside the Final Approach Fix (FAF). The Approach (APPR) mode must be annunciated on both the PFD and the GPS.

NAV Mode Operation – GPS Navigation

1. With a valid flight plan programmed and active in the GPS, use the CDI Source Select button to couple the GPS to the PFD (see **Section 4.4.5.**).
2. If AUTO CRS is disabled, set the Course Pointer to the desired course (CRS) (see **Section 4.4.7.**), or enable AUTO CRS (see **Section 4.4.6.**).
3. With GPSS disabled, set the PFD Heading Bug (see **Section 4.4.9.**) to a value that will intercept the active leg of the flight plan, or enable GPSS via the GPSS Hot Key.
4. Engage the autopilot in Heading (HDG) mode and verify that the aircraft turns to a heading to intercept the active leg of the flight plan.
5. If your autopilot supports automatic heading to nav mode transitions, arm the navigation capture on the autopilot by selecting its Navigation (NAV) mode. Otherwise, select the autopilot Navigation (NAV) mode when the autopilot navigation signal capture criteria are satisfied (see your autopilot AFMS for more information).
6. Monitor the PFD CDI deflection and verify that, upon intercepting the flight plan leg, the autopilot modes transition appropriately and the autopilot tracks the desired course.

APPR Mode Operation – ILS Approach with Vectors to Final

1. Using the CDI Source Select button, couple a tuned/valid ILS radio frequency to the PFD CDI, and adjust the course (CRS) (**Section 4.4.7**).
2. Set the PFD Heading Bug to a value that will intercept the desired course, or as instructed by ATC (**Section 4.4.9**).
3. Engage the autopilot in Heading (HDG) and Altitude (ALT) Hold modes and verify that the aircraft turns to the desired heading.
4. Once cleared for the ILS approach, arm the autopilot's Approach (APPR) mode, or continue to fly Heading (HDG) mode until the CDI centers.
5. Monitor the CDI's deflection and verify (if supported by your autopilot) that, upon intercepting the localizer, the autopilot switches to Approach (APPR) capture, and tracks the localizer course. Otherwise, engage the autopilot Navigation or Approach mode per the procedures in your autopilot's AFMS.
6. Monitor the autopilot localizer tracking performance. Upon intercepting the glide slope, verify that the autopilot captures the Glide Slope (GS) and initiates a descent to track the glide slope.

 **NOTE**

WAAS GPS navigators can provide vertical guidance on several types of GPS/RNAV instrument approaches. RNAV (GPS) APV (Approaches with Vertical Guidance), such as LPV and LNAV/VNAV approaches, often have lower approach minima shown on the approach plate. Aircraft equipped with appropriate WAAS GPS equipment may use these lower minima.

Even with more traditional lateral guidance-only GPS/RNAV approaches (e.g. LNAV) with step-down altitudes) WAAS GPS may still provide a pseudo-glide slope that enables a continuous descent to the MDA (Minimum Descent Altitude). The autopilot may consider this a glide slope and attempt to fly it. For this type of instrument approach, the vertical guidance is advisory only and the MDA is the appropriate approach minimum.

These types of approaches are set up and flown the same way, much like an ILS approach. The pilot must be aware of the differences and which minima to use.

APPR Mode Operation – GPS or GPS/RNAV APV WAAS Approach

1. With a valid GPS approach programmed in the GPS, use the CDI Source Select Button to couple the GPS to the PFD (see **Section 4.4.5**).
2. If AUTO CRS is disabled, set the Course Pointer to the desired course (see **Section 4.4.7**), or enable AUTO CRS (see **Section 4.4.7**).
3. With GPSS disabled, set the PFD Heading Bug to a value that will intercept the active leg of the flight plan (see **Section 4.4.9**) or enable GPSS via GPSS Hot Key.
4. Engage the autopilot in Heading (HDG) mode and verify that the aircraft turns to a heading to intercept the active leg of the approach.
5. For autopilots that do not support automatic heading mode to Navigation (NAV) or Approach (APPR) mode transitions, use the Heading Bug to establish the aircraft inbound to the Final Approach Fix (FAF) and then engage the autopilot's Approach (APPR) mode.
6. For autopilots that support automatic Heading (HDG) to Approach (APPR) mode transitions, monitor the PFD CDI and verify that, upon intercepting the active leg of the approach, the autopilot turns to track the GPS approach course guidance.

THE FOLLOWING APPLY FOR WAAS GPS/RNAV APV APPROACHES ONLY

7. Once cleared for the GPS/RNAV approach, select the autopilot's Approach (APPR) mode.
8. Monitor the PFD CDI and verify that the autopilot intercepts and tracks the final approach course and the GPS switches to its Approach mode.
9. Most WAAS GPS navigators will not arm or activate vertical guidance until the aircraft is within two miles of the FAF (unlike an ILS where the VDI will display as soon as the aircraft is established on the final approach course and a valid localizer signal with glide slope signal is received). As you approach the FAF, watch for the VDI to appear on the PFD Attitude Display. This indicates that the autopilot is ready to capture the glide slope.
10. Monitor the autopilot lateral approach course tracking with the PFD CDI and LDI. Upon intercepting the WAAS GPS glide slope, verify that the autopilot switches captures the glide slope and starts a descent.

GPS APPR Mode Operation – WAAS GPS Underlay to ILS Approach Using Pilot Navigation and GPSS

1. With a valid ILS approach loaded and activated in the GPS, use the CDI Source Select button to couple the GPS to the PFD CDI (see **Section 4.4.5.**).
2. Verify that the correct ILS frequency is tuned.
3. When the active flight plan leg is the course to the Initial Approach Fix (IAF), enable GPSS via the GPSS Hot Key.
4. Engage the autopilot in Heading (HDG) and Altitude (ALT) Hold modes and verify that the aircraft continues to fly the course to the IAF.
5. Monitor the PFD CDI and aircraft track to ensure the aircraft flies to the IAF and then turns outbound for the course reversal.
6. A WAAS GPS navigator provides guidance along curved flight paths, and will guide the aircraft through the course reversal and establish it inbound to the FAF without pilot intervention.
7. Once established on the final approach course to the FAF, engage the autopilot's Approach (APPR) mode.
8. Use the PFD CDI Source Select button to change to the VLOC for the approach (if not done automatically by the GPS/nav receiver).
9. Monitor the PFD CDI localizer deflection and verify that, upon intercepting the localizer, the autopilot captures the final approach course and switches to the Approach (APPR) mode.
10. Monitor the autopilot localizer tracking performance. Upon intercepting the glide slope, verify that the autopilot captures glide slope and initiates a descent.

NOTE

The PFD supports GPS LPV approaches (Approaches with Vertical Guidance) by providing the autopilot with GPS lateral and vertical deviation signals that are identical to those typically provided by an ILS radio. To fly GPS LPV approaches, configure and operate the autopilot as you would for an ILS approach.

NOTE

Some IFR GPS navigators include ILS approaches in their procedures database. GPS may be used to navigate the initial segments of the ILS approach, but the pilot must switch to VLOC navigation outside the FAF and before glide slope intercept.

Some integrated GPS/NAV receivers (like the Garmin 4xx/5xx series) can be configured to switch automatically, and the PFD Selected CDI Navigation Source will follow automatically. It is the pilot's responsibility to verify that the PFD CDI source is correctly set to VLOC# before reaching either glide slope intercept or the FAF.

GPS APPR Mode Operation – WAAS GPS Underlay to ILS Approach With ATC Vectors to Final

1. With a valid ILS approach loaded and activated in the GPS, use the CDI Source Select Button to couple the PFD GPS to the CDI (see **Section 4.4.5**).
2. Verify that the correct ILS frequency is tuned.
3. Set the Heading Bug to the heading assigned by ATC (see **Section 4.4.9**).
4. Disable GPSS via the GPSS Hot Key.
5. Engage the autopilot in Heading (HDG) mode and verify that the aircraft turns to the Selected Heading.
6. When cleared for the approach and given the final heading to intercept the final approach course by ATC, arm the autopilot's Approach (APPR) and Altitude (ALT) Hold modes.
7. Monitor the CDI and aircraft track to verify that the autopilot intercepts the final approach course and begins to track inbound to the FAF.
8. Use the PFD CDI Navigation Source Select Button to change to the VLOC source for the approach (if not done automatically by the GPS/nav receiver).
9. Monitor the PFD CDI localizer deflection and verify that, upon intercepting the localizer, the autopilot captures the final approach course and switches to the Approach (APPR) mode.
10. Monitor the autopilot localizer tracking performance. Upon intercepting the glide slope, verify that the autopilot captures the glide slope and initiates a descent to.

4.8. Hazard Awareness¹

Evolution Hazard Awareness (EHA) offers three hazard awareness options;

- Lightning (Data Link Weather and Stormscope® WX-500)
- NEXRAD
- Traffic

Each option requires additional sensors. For Data Link Lightning and NEXRAD, an additional subscription to XM WX Satellite Weather is required. Each hazard awareness option is accessed by a Hot Key and displayed on the Navigation Display (Figure 4-114).

4.8.1. Lightning Overlay¹

The LTNG Hot Key is a three position Hot Key (LTNG, STRK, and CELL) that permits display of satellite lightning information or Stormscope® WX-500 data overlaid on the HSI.

When enabled, the lightning displays as described in Table 4-5. The LTNG Hot Key label is inverse green (green label and dark blue letters) when enabled or a blue label and green letters when disabled.



Figure 4-114
Navigation Display Showing
Hazard Awareness

1. Not available with the Pilot PFD

NOTE

WX-500 Lightning Symbols and rate annunciation are removed from the Basemap for ranges less than 20nm.



Figure 4-121
WX-500 Data is Not Available

NOTE

WX-500 data will not display, and the rate annunciation displays with a red line when the Stormscope receiver reports a fault or error, aircraft heading is invalid or unavailable, or WX-500 data is not detected (Figure 4-121).







Hot Key	Display Symbol	Annunciation	Description
LTNG	 <p>Figure 4-115 Data Link Lightning Symbol</p>	 <p>Figure 4-116 Lightning Time</p> <p>Annunciation displays in the lower left corner of the Navigation Display showing the age of received data.</p>	<p>Data Link Lightning Symbols display as cyan lighting symbols at full intensity for 5 minutes after information is received.</p> <p>Symbols are positioned on the display relative to the Ownship Symbol.</p> <p>After 5 minutes, the symbols will fade over the next 15 minutes.</p>
STRK	 <p>Figure 4-117 WX-500 Strike Symbol</p>	 <p>Figure 4-118 WX-500 Strike Rate</p> <p>Annunciation displays in the lower left corner of the Navigation Display showing the current strike rate.</p>	<p>Symbols are positioned on the display relative to the Ownship Symbol.</p>
CELL	 <p>Figure 4-119 WX-500 Cell Symbol</p>	 <p>Figure 4-120 WX-500 Cell Rate</p> <p>Annunciation displays in the lower left corner of the Navigation Display showing the current cell rate.</p>	<p>Symbols are positioned on the display relative to the Ownship Symbol.</p>

Table 4-5
Lighting Display

Display Lightning

1. Select the 2/2 Hot Key Menu.
2. Press the LTNG Hot Key to select the desired option.

The LTNG Hot Key label turns inverse green when enabled. Each press of the Hot Key cycles through the available options; LTNG, STRK, CELL, or LTNG disabled. (STRK is selected in **Figure 4-122**).

4.8.2. Data Link Weather Overlay¹

The NXRD Hot Key enables the display of NEXRAD (Next Generation Radar) and precipitation data overlaid on the Navigation Display relative to the Ownship Symbol. The Hot Key label is green when enabled and gray when disabled. The Data Link Weather default setting is off. NEXRAD coverage includes:

- U.S. and Puerto Rico NEXRAD
- U.S. Precipitation type
- Canada Radar
- U.S. NEXRAD Coverage
- Canada Coverage

Display Data Link Weather

1. Select the 2/2 Hot Key Menu.
2. Press the NXRD Hot Key to enable Data Link Weather

The NXRD Hot Key label turns inverse green when enabled (**Figure 4-123**).



Figure 4-122
Lightning Overlay Enabled
Displaying WX-500 Strike Data



Figure 4-123
Data Link Weather Enabled

NOTE

When Strike or Cell mode is displayed, pressing and holding the CELL or STRK Hot Key will reset the respective RATE to zero and remove all stormscope symbols from the display. This function may also be performed from the MENU.

NOTE

When US and Puerto Rico NEXRAD and Canada Radar exceeds the specified expiration time, the depiction for the respective radar is rendered as no Radar Coverage.

1. Not available with the Pilot PFD

NOTE

Areas of no coverage are gray. If the aircraft is on the ground before data is received, or in an area of no coverage and the range setting is low, the entire HSI may be underplayed in translucent gray.

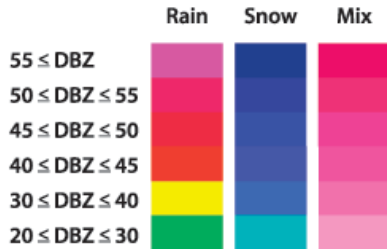

Figure 4-124
NEXRAD Radar Data



Figure 4-125
Data Link Weather Legend

NEXRAD coverage displays using the following methodology:

- If US Precipitation Type is unavailable and US NEXRAD Radar is available, the US weather depiction is displayed as rain.
- If US Precipitation Type is available and US NEXRAD Radar is unavailable, the US weather depiction is not displayed.
- If US coverage is unavailable or expired and US NEXRAD is available, the US weather depiction is displayed as if all US radar sites are valid.
- If Canada coverage is unavailable and Canada radar is available, the Canada weather depiction is displayed as if all US radar sites are valid.
- If US NEXRAD Radar or Canada Radar exceed the specified expiration time, the depiction for the respective radar is displayed as no Radar Coverage.
- If Puerto Rico NEXRAD Radar exceeds the specified expiration time, the Puerto Rico NEXRAD Radar depiction for the respective radar displays as no Radar Coverage.
- Radar data is displayed as outlined in **Figure 4-124**. Areas without radar coverage are indicated by translucent gray. Radar cells indicating reflectivity below 10 dBZ are not displayed. The PFD offers a Data Link Weather legend accessible from the MENU.

Display Data Link Weather Legend

1. Press the MENU Button.
2. Rotate the Right Knob to the XM RECEIVER C Menu page.
3. Press and hold the HOLD FOR LGND Menu Key.

The Data Link Weather Legend displays until the Menu Key is released (**Figure 4-125**).

4. Press the MENU Button to exit.

When the Data Link Weather is enabled, an age annunciation is shown in the lower left corner of the Navigation Display (**Figure 4-126**). The age annunciation indicates the elapsed time in minutes since the information was generated. Each weather product has an age limit and is usually updated at the update frequency indicated in **Table 4-6**.

The age of each weather product is displayed in XM RECEIVER B and XM RECEIVER C Menu pages (**Figure 4-126**).



Figure 4-126
Data Link Weather Product Age

Weather Product	Expiration Time (min.)	Update Frequency (min.)
U.S. NEXRAD	30	5
Puerto Rico NEXRAD	30	5
High Resolution (Canada) Radar	30	10
U.S. Radar Coverage	30	5
Canada Radar Coverage	30	10
Precipitation Type	30	5
Data Link Lightning	30	5

Table 4-6
Weather Product Age Limits and Update Frequency

View Data Link Weather Age

1. Press the MENU Button.
2. Rotate the Right Knob to the XM RECEIVER B Menu page.

The age of each Data Link Weather product is shown (**Figure 4-126**).

3. Press the MENU Button to exit.

The data age (except Puerto Rico NEXRAD) will display in Amber whenever the data link receiver has failed or stops reporting. When the expiration time has been reached and no updates have been received, the age annunciation is shown with a red slash and all data are removed from the Navigation Display. **Table 4-7** describes the age annunciations.





Age Annunciation	Conditions
	NEXRAD data is being received and updated.
	The data link receiver has failed or the data are unavailable, but not expired and may still be valid. Check local weather conditions.
 	<p>NEXRAD data are removed and the age annunciation is slashed with a red line, for any of the following conditions:</p> <ul style="list-style-type: none"> • The age of the data exceeds the expiration time identified in Table 4-6; additionally, the corresponding NEXRAD data are removed from the display. • The data age of all displayed products exceeds the specified expiration time. • No valid data have not yet been received for 15 minutes. • GPS position information is unavailable or invalid.
	Valid data has not yet been received from the NEXRAD receiver after the PFD is turned on.

Table 4-7
Weather Age Annunciations

4.8.3. Traffic Overlay¹

The TRFC Hot Key enables the traffic display overlaid on the Navigation Display when the PFD is configured with one of the following traffic sensors:

- Avidyne TAS 600/610/620 (TAS)
- Bendix/King KMH 880 (TAS)
- Bendix/King KTA 870 (TAS)
- Garmin GTX 330 (TIS)
- RYAN 9900BX (TAS)
- SKYWATCH SKY 497 (TAS)
- SKYWATCH SKY 899 (TAS)

The TRFC Hot Key enables the Traffic Overlay and the selection of a Traffic Altitude Filter. The Hot Key Label is inverse green (green label with dark blue letters) when enabled (**Figure 4-127**) or a blue label with green letters when disabled.

When the Traffic Overlay is enabled, a TRFC annunciation is presented on the lower left of the Navigation Display. The traffic setting that was previously reset over a power cycle is retained as last configured by the pilot.

Display the Traffic Overlay

1. Select the 2/2 Hot Key Menu.
2. Press the TRFC Hot Key to select the desired Altitude Filter.



Figure 4-127
Traffic Overlay Enabled

NOTE

Because of their importance, the PFD will show Traffic Advisories on the Navigation Display even when Traffic Overlay is disabled.

1. Not available with the Pilot PFD



Figure 4-128
Traffic Symbology

NOTE

Refer to your traffic sensor's Pilot Guide for detailed information about the sensor limitations and operational ranges.

Additionally, see the Aeronautical Information Manual section entitled *Traffic Information Service (TIS)* for detailed information about TIS requirements, capabilities and limitations..

4.8.3.1. Traffic Symbols¹

The PFD will display traffic symbols prioritized in the order received from the configured traffic sensor. The PFD includes three threat levels using TCAS symbology; Traffic Advisory (amber circle), Proximity Advisory (cyan diamond), and Other Traffic (hollow cyan diamond). All traffic symbols within the current display range and the selected altitude filter are shown relative to the Ownship Symbol (**Figure 4-128**).

The Traffic Advisory System (TAS) use an airborne interrogator with a half-second update rate; coverage follows the aircraft. The Traffic Information Service (TIS) system use a GTX 330 transponder with a five-second update rate; coverage is limited to specific areas listed in the Aeronautical Information Manual (AIM).

WARNING

Do not rely on the PFD as the sole source of data for collision avoidance. It is the pilot's responsibility to visually acquire other aircraft for safe flight. Maneuver your aircraft based only on ATC guidance or positive acquisition of conflicting traffic. Traffic information is:

- *Provided as a proximity warning only*
- *Intended to assist the pilot in the visual acquisition of other aircraft*
- *Not intended to provide recommended avoidance maneuvers*
- *Not provided for aircraft that are not transponder equipped, experiencing a transponder failure, or out of radar coverage*

1. Not available with the Pilot PFD

The PFD displays traffic information from the sensor with the threat level assigned by the sensor. The sensor and type of traffic system defines the threat data, range, bearing, altitude, and altitude trend. Each traffic symbol is positioned at a location representing the relative range and bearing to the Ownship Symbol.

A data block is provided for each traffic symbol with the relative altitude and vertical direction (as acquired from the sensor). The data block text color is the same as the traffic symbol, amber for Traffic Advisories and cyan for Proximity Advisories and Other Traffic (**Figure 4-129**).

The relative altitude is shown as two digits indicating the relative altitude difference, in hundreds of feet, from your aircraft. The altitude value for traffic above the ownship is preceded by a plus symbol (+) and is displayed under the symbol. The altitude value for traffic below the ownship is preceded by a minus symbol (-) and is displayed under the symbol.

An arrow next to the traffic symbol gives the direction of vertical movement in relation to the your aircraft. Traffic climbing or descending at a rate greater than 500 fpm are given an up-arrow (climbing), or down-arrow (descending) to the right of the traffic symbol. Traffic that is at the same altitude, with no vertical trend, is given an altitude value of 00 below the traffic symbol.

For example, the Traffic Advisory shown in **Figure 4-128** is 400 feet above your aircraft and descending. No altitude information is shown in the data block when the altitude is unavailable.

Traffic Advisories that are outside the current range are indicated by a half-symbol at the edge of the Navigation Display with the appropriate data block. Proximity Advisories and Other Traffic that are outside of the current range are not displayed.

When multiple traffic symbols partially or completely overlap, the symbols are visually stacked, with the highest priority alert data on top, obscuring the lower priority alert.



Figure 4-129
Traffic Symbol Data Block

NOTE

Traffic that is within 100 feet of the ownship shown an altitude value of 00, above or below the traffic symbol as appropriate.

NOTE

When the traffic is flying level, no arrow is shown. When the traffic is not reporting an altitude, neither the arrow nor the altitude indication is shown.

NOTE

Depending on the position of the Traffic Advisory at the edge of the screen, the traffic symbol data block may or may not display.

NOTE

The altitude filters listed in Table 4-8 are referenced to your aircraft and the PFD altitudes. The traffic sensor configured with the PFD may have different (i.e., lower) altitude thresholds. Check your traffic sensor pilot's manual for specifics.



Figure 4-130
Traffic Altitude Filter

When a traffic symbol and the Ownship Symbol partially or completely overlap, the traffic symbol and data block will overlay the ownship symbol.

4.8.3.2. Traffic Altitude Filter¹

There are five Altitude Filters available: Off, Normal, Unrestricted, Above, and Below (**Table 4-6**). Only traffic within the selected altitude filter value will display.

Hot Key Label	Altitude Filter Level	Traffic Display Volume
TRFC	Off	None
TFCN	Normal	±2,700 ft
TFCU	Unrestricted	±9,900 ft
TFCA	Above	+9,900 ft to -2,700 ft
TFCB	Below	+2,700 ft to -9,000 ft

Table 4-8
Traffic Filter Parameters

The pilot adjusts the altitude filter value by continuously pressing the TRFC Hot Key, which cycles through each of the filter levels.

Change the Traffic Altitude Filter

1. Select the 2/2 Hot Key Menu
2. Press the TRFC Hot Key to select the desired filter level.

The TRFC annunciation displays in the lower left of the display (**Figure 4-117**).

¹. Not available with the Pilot PFD

4.8.3.3. Traffic Unavailable¹

When the TAS (Traffic Advisory System) sensor's status is STANDBY, TEST or FAIL:

- an Invalid Traffic Sensor annunciation (**Figure 4-131**) is displayed and the Traffic symbols are removed from view

When the traffic interface is a TIS (Traffic Information Service) and the Traffic data is:

- Unavailable – TRFC UNVL is annunciated
- Not refreshed within 6 seconds – TRFC COAST is annunciated
- Not refreshed within 12 seconds – TRFC RMVD is annunciated and the Traffic symbols are removed from view
- Not refreshed for 60 seconds – TRFC RMVD annunciation is removed from view



Figure 4-131
Traffic Sensor Invalid

1. Not available with the Pilot PFD

This Page Intentionally Left Blank

Chapter 5

Customizing the PFD

5.1. Menu Overview

The following tables and figures provide a brief overview of each menu page and its menu options.

KEY DESCRIPTION		OPTIONS
1	Displays Airspeed and Altitude Tapes ¹	DISABLE or ENABLE
2	Radio Altitude ²	DISABLE or ENABLE
3	Auto Course Select ²	DISABLE or ENABLE
4	ARC Compass Mode ²	HSI or CDI
5	AHRS Reset	Action

Table 5-1
Menu – GENERAL SETTINGS A

1. Available only in those installations where an additional airspeed indicator and altimeter are added or retained within the pilot's maximum field of view.
2. Not available with the Pilot PFD



Figure 5-1
GENERAL SETTINGS A



Figure 5-2
GENERAL SETTINGS B

KEY DESCRIPTION	OPTIONS
1	Barometer Pressure Setting Units of Measure in Hg or mB
2	Outside Air Temperature Units of Measure °C or °F
3	Clear WX-500 Strike/Cell Count ^{1,2} Action
4	WX-500 Strike Test ^{1,2} Action
5	Auto Range DISABLE or ENABLE

Table 5-2
Menu – GENERAL SETTINGS B

1. Pro PFD Only when configured with Stormscope® WX-500.
2. Not available with the Pilot PFD

KEY DESCRIPTION		OPTIONS
1	MACH Display	<u>ALTITUDE:</u> OFF, ON>5K, ON>6K, ON>7K, ON>8K, ON>9K, ON>10K, ON>11K, ON>12K, ON>13K, ON>14K, ON>15K, ON>16K, ON>17K, ON>18K
		<u>SPEED:</u> OFF, ON>0.1, ON>0.2, ON>0.3, ON>0.4, ON>0.5, ON>0.6, ON>0.7
2	Overspeed Warning Test	Action

Table 5-3
Menu – GENERAL SETTINGS C



Figure 5-3
GENERAL SETTINGS C



Figure 5-4
360° MAP SETTINGS

KEY DESCRIPTION		OPTIONS
1	360° Declutter Level	0, 1, 2, 3, 4
2	360° Flight Plan	OFF, AUTO
3	360° Airports	OFF, AUTO
4	360° VORs (High, Low and Terminal)	OFF, AUTO
5	360° Intersections / NDB	OFF, AUTO

Table 5-4
Menu – 360° MAP SETTINGS

KEY DESCRIPTION		OPTIONS
1	ARC Declutter Level	0, 1, 2, 3, 4
2	ARC Flight Plan	OFF, AUTO
3	ARC Airports	OFF, AUTO
4	ARC VORs (High, Low and Terminal)	OFF, AUTO
5	ARC Intersections / NDB	OFF, AUTO

Table 5-5
Menu – ARC MAP SETTINGS



Figure 5-5
ARC MAP SETTINGS

Figure 5-6
VSPEEDS AFigure 5-7
VSPEEDS B

KEY DESCRIPTION	OPTIONS	
1	VSPEEDS	DISABLE or ENABLE
2	Va	0 to 450 or LOCKED
3	Vbg	0 to 450 or LOCKED
4	Vref	0 to 450 or LOCKED
5	Vr	0 to 450 or LOCKED

Table 5-6
Menu – VSPEEDS A

KEY DESCRIPTION	OPTIONS	
1	Vx	0 to 450 or LOCKED
2	Vy	0 to 450 or LOCKED
3	Vlo	0 to 450 or LOCKED
4	Vle	0 to 450 or LOCKED

Table 5-7
Menu – VSPEEDS B

NOTE

When V Speeds are LOCKED at installation, the legend and set value are shown in gray. Setting any of the above values to zero removes the affected V Speed.

KEY DESCRIPTION		OPTIONS
1	XM Serial Number ^{1,2}	Status Only
2	XM Receiver Signal Quality ^{1,2}	Status Only
3	XM Status ^{1,2}	Status Only

Table 5-8
Menu – XM RECEIVER A

1. Pro PFD Only when configured with an EWR50 Weather Receiver and a subscription to XM WX Satellite Weather®.
2. Not available with the Pilot PFD



Figure 5-8
XM RECEIVER A



Figure 5-9
XM RECEIVER B

KEY DESCRIPTION		OPTIONS
1	US NEXRAD Age ^{1,2}	Status Only
2	Puerto Rico NEXRAD Age ^{1,2}	Status Only
3	Lightning Age ^{1,2}	Status Only
4	Precipitation Age ^{1,2}	Status Only
5	US Coverage Age ^{1,2}	Status Only

Table 5-9
Menu – XM RECEIVER B

1. Pro PFD Only when configured with an EWR50 Weather Receiver and a subscription to XM WX Satellite Weather®.
2. Not available with the Pilot PFD

KEY DESCRIPTION		OPTIONS
1	Canada Radar Age ^{1,2}	Status Only
2	Canada Coverage Age ^{1,2}	Status Only
3	Display Weather Legend ^{1,2}	Action

Table 5-10
Menu – XM RECEIVER C

1. Pro PFD Only when configured with an EWR50 Weather Receiver and a subscription to XM WX Satellite Weather®.
2. Not available with the Pilot PFD



Figure 5-10
XM RECEIVER C



Figure 5-11
POWER SETTINGS

NOTE

For external/battery power control, the legend of the current power source is shown in green; pressing the associated menu key will perform no action. The legend of an available power source is shown in white, and pressing the associated menu key changes input power to that power source.

KEY DESCRIPTION		OPTIONS										
1	Operating from or Switch to Battery Power. Green when current state (Pressing key performs no action). White if selection is possible.	Status or Action										
2	Operating from or Switch to External Power. Green when current state (Pressing key performs no action). White if selection is possible.	Status or Action										
3	Restart (Depending on Air/Ground Logic State).	Action										
4	External Power Source Voltage. Displays voltage level of input power.	Status Only										
5	<table border="1"> <thead> <tr> <th>Battery Status</th> <th>Description</th> </tr> </thead> <tbody> <tr> <td>##%</td> <td>Displays battery % charge.</td> </tr> <tr> <td>CHARGING</td> <td>The battery has sufficient voltage and can accept charging, aircraft power is available, and the temperature sensor is within limits (0°C to +55°C).</td> </tr> <tr> <td>FAILED</td> <td>The battery voltage is less than 6 volts; i.e. insufficient for charging.</td> </tr> <tr> <td>READY</td> <td>The connected battery and battery voltage are satisfactory, but the temperature limits (0°C to +55°C) that will permit charging have been exceeded.</td> </tr> </tbody> </table>	Battery Status	Description	##%	Displays battery % charge.	CHARGING	The battery has sufficient voltage and can accept charging, aircraft power is available, and the temperature sensor is within limits (0°C to +55°C).	FAILED	The battery voltage is less than 6 volts; i.e. insufficient for charging.	READY	The connected battery and battery voltage are satisfactory, but the temperature limits (0°C to +55°C) that will permit charging have been exceeded.	Status Only
	Battery Status	Description										
	##%	Displays battery % charge.										
	CHARGING	The battery has sufficient voltage and can accept charging, aircraft power is available, and the temperature sensor is within limits (0°C to +55°C).										
FAILED	The battery voltage is less than 6 volts; i.e. insufficient for charging.											
READY	The connected battery and battery voltage are satisfactory, but the temperature limits (0°C to +55°C) that will permit charging have been exceeded.											

Table 5-11
Menu – POWER SETTINGS

KEY DESCRIPTION		OPTIONS
1	Main Application Processor Software Version	Status Only
2	Input Output Processor Software Version	Status Only
3	Unit Serial Number	Status Only

Table 5-12
Menu – SYSTEM STATUS



Figure 5-12
SYSTEM STATUS



Figure 5-12
360° Compass Mode Display Options



Figure 5-13
ARC Compass Mode Display Options

5.2. Customizing Basemap Symbol Declutter Settings

The pilot can customize the Basemap symbol declutter settings to Level 4, Level 3, Level 2, Level 1, or Level 0 (OFF) by pressing the MENU Button and selecting the 360 MAP SETTINGS Menu page or the ARC MAP SETTINGS Menu page.

Each Compass Mode has its own Menu page for Map Setting basemap symbol display.

- The 360 MAP SETTINGS Menu page offers Map Setting options for the 360° Compass Mode (**Figure 5-12**).
- The ARC MAP SETTINGS Menu page offers Map Setting options for the ARC Compass Mode (**Figure 5-13**).

As described in **Table 5-9**, the selected declutter level and range determine which Basemap symbols are displayed. Basemap symbol identifiers may also be shown next to their symbol.

See **Chapter 4, Section 4.4.1** for more details about Compass Mode options

Set Map Symbol Display

1. Press the MENU Button.
2. Rotate the Right Knob to navigate to the appropriate Map Settings Menu page.
3. Press the desired Map Symbol Menu Key.
The menu label turns magenta, and the EDIT VALUE label displays above the Right Knob (**Figure 5-14** and **5-15**).
4. Rotate the Right Knob to the desired value.
5. Select another Map Symbol Menu Key and edit the display option or press the MENU Button to exit.



Figure 5-14
Editing 360° NDB Display Option



Figure 5-15
360° NDB Display Option Set To OFF





Feature Group and Layer Order (from Top to Bottom)		Max Range	Declutter Setting					
			 Figure 5-16 Level 4	 Figure 5-17 Level 3	 Figure 5-18 Level 2	 Figure 5-19 Level 1	 Figure 5-20 Level 0 (Off)	
Traffic Overlay Symbols	1	Overlay – enabled via Hot Key	Always ON, regardless of declutter level					No symbols, legs, or waypoints—regardless of selected range—are displayed. When selected, the basemap declutter and range display for two seconds and then are removed from view. The MAP Hot Key legend is shown in gray.
Ownship Symbol	2		Always ON, regardless of declutter level					
Instruments ¹ and Annunciations ²	3		Always ON, regardless of declutter level					
Flight Plan Legs and Waypoints ³	4	200	●	●	●	●		
Airports ³	5	100	●	●	●			
NDBs ³	6	15	●					
VORs, (HIGH, LOW, Terminal) ³	7	200	●	●				
Intersections	8	15	●					
WX-500 or Data Link Lightning	9	Overlay – enabled via Hot Key	Always ON ⁴					
NEXRAD Weather	10	Overlay – enabled via Hot Key	Always ON					

Table 5-12
Map Feature Group Layering, Range, and Declutter Levels

1. e.g., VSI, Direction Indicator, CDI, TO/FROM.
2. e.g., NAV INFO Block, Range.
3. Shown only when data is provided by a compatible and connected GPS system.
4. Removed at ranges less than 20nm.

5.3. Configuring Vspeeds

Vspeeds are used to designate different operating speeds of the aircraft and are defined in **Table 5-13**.

Vspeed	DEFINITION	PRE-SET BANDS	ADJUSTABLE TEXT LABELS	PRE-SET MARKERS
Vne	Never exceed	●		● (Red Line)
Vno	Maximum structural cruising speed	●		
Vfe	Maximum full flap extension speed	●		
Vs	No flap stall	●		
Vso	Stall speed in landing configuration	●		
Va	Design maneuvering speed		●	
Vbg	Best glide		●	
Vr	Rotation speed		●	
Vref	Landing reference speed		●	
Vx	Best angle of climb		●	
Vy	Best rate of climb		●	
Vle	Maximum landing gear extended speed		●	

 **NOTE**

Setting the value of the white triangle, V_{yse} , and V_{mc} markers to zero (0) during installation disables the markers. Setting any of the adjustable V_{speed} values to zero (0) disables the associated label.

Vspeed	DEFINITION	PRE-SET BANDS	ADJUSTABLE TEXT LABELS	PRE-SET MARKERS
V_{lo}	Maximum landing gear operating speed		●	
V_{mc}	(Multi-engine) Single-engine minimum control airspeed			● (Red Line)
V_{yse}	(Multi-engine) Best single-engine rate of climb			● (Blue Line)
	Maximum initial flap extension speed			●

Table 5-13
Vspeed Definitions

The PFD uses color speed bands, color speed markers, and textual labels to help the pilot recall Vspeed settings and limits. The speed band markings are determined by the Federal Regulations and correspond to the aircraft operating speeds that are identified in the Aircraft Flight Manual. They have a range between two speeds that are pre-set at installation as outlined in **Table 5-14** and shown in **Figure 5-21**.

Speed markers are also pre-set during installation, indicating important aircraft-specific speeds, where applicable. The textual Vspeed labels are made pilot adjustable or locked during the PFD installation.

BAND COLOR	SPEED RANGE	
Red Band (High Speed)	Vne (Top of tape)	Never Exceed
Yellow Band	Vno – Vne	Caution Range
Green Band	Vs – Vno	Normal Operating Range
White Band	Vs0 – Vfe	Flap Operating Range
Red Band (Low Speed)	Vs0 (Bottom of tape)	Disabled on the ground and during takeoff

Table 5-14
Speed Band Ranges



Figure 5-21
Speed Bands

NOTE

The color speed bands and color speed markers on the PFD Airspeed Tape are configured to match the certified mechanical airspeed indicator.

NOTE

On aircraft without flaps, the white band is disabled, and the green band is shown full width, as there isn't an applicable Flap Extend (Vfe) or Full Flap Stall (Vs0) speed. These two speeds are set to the same speed as the No Flap Stall (Vs) speed. This gives the white band a value of zero, effectively disabling it.



Figure 5-22
VSPEEDS A



Figure 5-23
Editing VSPEEDS



Figure 5-24
VSPEEDS Disabled

On aircraft with flaps, setting the upper and lower thresholds of the white and/or yellow bands to the same value disables the applicable band. When disabled, the band does not display.

When using the Vspeed textual markers, the pilot must first ENABLE the display of the markers and then set values for each Vspeed. The value range for Vspeed textual markers is 0 – 450 or LOCKED. The default setting is 0 unless previously set to another value. When the value is 0, the Vspeed is individually disabled, and the marker is not shown on the Airspeed Tape. Once the values are set, the pilot can choose to disable all the Vspeed textual markers to declutter the Airspeed Tape.

Display or Hide the Vspeed Textual Markers on the Airspeed Tape

1. Press the MENU Button.
2. Rotate the Right Knob to the VSPEEDS A Menu page (**Figure 5-22**).
3. Press the VSPEEDS Menu Key.
The Menu label turns magenta, and the EDIT VALUE label displays above the Right Knob (**Figure 5-23**).
4. Rotate the Right Knob to select ENABLE or DISABLE (**Figure 5-24**).
ENABLE will display the Vspeeds on the Airspeed Tape and DISABLE will hide the Vspeeds to declutter the Airspeed Tape
5. Press the MENU Button to exit.

Set Textual Vspeed Labels

1. Press the MENU Button.
2. Rotate the Right Knob to the appropriate Vspeed Menu page (**Figure 5-25**).
3. Press the appropriate Vspeed Menu Key.
The Menu label turns magenta, and the EDIT VALUE label displays above the Right Knob (**Figure 5-26**).
4. Rotate the Right Knob to the desired value (**Figure 5-27**).
5. Select another Menu Key to edit another Vspeed or press the MENU Button to exit.



Figure 5-25
VSPEDS A



Figure 5-26
Editing Va Vspeed



Figure 5-27
Va Vspeed Set With New Value

NOTE

A typical installation sets the Airspeed Textual Markers to UNLOCKED, allowing the pilot to edit the indicated Vspeed labels. If the Vspeed setting was LOCKED during installation, no pilot adjustment is allowed.



Figure 5-28
Display Brightness in BRT AUTO Mode



Figure 5-29
Display Brightness in BRT ADJUST Mode

NOTE

When the PFD is operating on the internal battery, the maximum brightness level is capped at 40% in automatic mode and 70% in manual mode to preserve battery operating time.

NOTE

To facilitate cooling of the PFD display unit, when the backlight temperature is greater than or equal to 70°C, the display brightness level is limited to 30% in automatic mode and 70% in manual mode. The limits are removed when the PFD display temperature drops below 60°C.

5.4. LCD Brightness Control

The LCD brightness of the PFD operates in either of two modes, Automatic or Manual (Figures 5-28 and 5-29). The LCD brightness range is displayed as a value from 1–100, displayed above the Left Knob.

LCD MODE	DESCRIPTION
AUTOMATIC BRT AUTO	LCD backlight intensity is automatically adjusted based on the ambient lighting conditions sensed by the Automatic Dimming Photocell (Figure 5-28). When using the auto-brightness, the maximum brightness level is 70%.
MANUAL BRT ADJUST	Allows the pilot to adjust the LCD backlight intensity. (Figure 5-29) from 1–100%.

Table 5-15
Brightness Control

Change Brightness Mode

1. Press the MENU Button.
2. Press the Left Knob to select the desired LCD Brightness Control mode, either Automatic (BRT AUTO) (Figure 5-28), or Manual (BRT ADJUST) (Figure 5-29).
3. Press the MENU Button to exit.

Adjust Display Brightness Manually

1. Switch to manual LCD Brightness Control mode (BRT ADJUST) (Figure 5-29).
2. Rotate the Left Knob clockwise to increase the display brightness or counterclockwise to decrease the display brightness. The BRT: value changes accordingly.
3. Press the MENU Button to exit and retain the selected brightness level.

Chapter 6

Expanded Emergency and Abnormal Procedures

This section supplements and provides an expanded description of the emergency and abnormal procedures included in the FAA-approved Aircraft Flight Manual Supplement. The information provided here is intended to provide additional background information to enhance the pilot's understanding of the emergency and abnormal conditions and the associated procedures provided in the AFMS. This pilot guide is provided for supplementary purposes only. The approved cockpit reference for in-flight use is the AFMS. Both the Pilot Guide and the AFMS must be immediately available to the pilot at all times in flight. In the event of any conflict between this document and the FAA-approved AFMS, the AFMS instructions must be followed.

6.1. Pitot/Static System Blockage

A pitot line blockage will result in the airspeed indicator behaving like an altimeter when the aircraft's altitude changes, and it will not respond to airspeed changes. A pitot line blockage can also affect the PFD's attitude indication.

A static line blockage will result in altitude remaining fixed and a zero vertical speed despite aircraft pitch and/or power setting changes. In addition, IAS indications will be incorrect if the static line is blocked. Errors will typically be noticed during climbs or descents. When descending, ambient pressure increases which will result in the indicated airspeed reading more than the actual airspeed. The opposite effect will be observed in a climb. A static line blockage can also affect the PFD's attitude indication.

Indication of an obstructed pitot system is provided for PFD when the PFD's indicated airspeed is less than 30 KIAS (35 mph) and GPS ground speed is greater than 50 kts (58 mph), then attitude and heading instruments are replaced with red Xs and textual annunciations to indicate their failure. In this case, an amber CHECK PITOT HEAT annunciation accompanies the ATTITUDE FAIL annunciation. When the pitot obstruction is subsequently removed and indicated airspeed \geq 30 KIAS (35 mph), the CHECK PITOT HEAT annunciation will be removed in 15 seconds. This indicates that the PFD is performing an automatic AHRS reset in the background. No pilot action is required to reset the system.

Blocked Pitot or Static Line Suspected

1. Turn Pitot heat ON
2. Open the Alternate Static Source
3. Refer to alternate attitude, airspeed, altitude, and heading sources for primary flight information
4. Consider exiting IMC
5. Land as soon as practicable



CAUTION

Most light aircraft have only a single pitot and static port available for flight instrument use. As such, the pitot and static lines used by the PFD are shared with those lines used by the standby airspeed indicator and altimeter. Should these lines become blocked, such as might occur due to an inadvertent icing encounter, the PFD, the standby airspeed indicators and the altimeters will display erroneous information.

Because the PFD uses pitot and static pressures as part of the ADAHRS solution, loss or corruption of this data, such as from a line blockage, will affect the attitude and heading information.

Whenever an erroneous pitot input is detected by the PFD in flight, it will replace the affected instruments with red Function Fail Xs and display a CHECK PITOT HEAT annunciation. In this case, the pilot should check pitot heat, select the aircraft's alternate static source and refer to secondary sources of attitude, airspeed, and heading information.

6.1.1. Identifying and Handling Suspected Pitot and/or Static System Failures

Blocked pitot and/or static system ports will compromise the PFD's attitude solution and soon cause it to Red-X (fail). Immediately begin flying by reference to backup attitude sources. Therefore, the pilot must be especially vigilant about verifying proper operation of the pitot and static systems both before and during flight.

It is important to check the pitot tube and static system ports, and to verify pitot heater performance, as part of a thorough pre-flight inspection, especially when anticipating flight in low IMC.

On takeoff roll, it is good practice to note and call out "airspeeds alive" when the airspeed indicators (both primary and backup) begin moving and to compare and call out readings at a pre-determined airspeed close to, but before rotation speed (e.g. "60 knots cross check"), consciously noting the performance on each takeoff. If the airspeed indicators do not come "alive" when they usually do or whenever there is a significant difference between the primary and backup indicators and sufficient runway is remaining, aborting the takeoff may be a prudent decision. Follow the Flight Manual procedures for your aircraft.

When the static port is blocked on takeoff, it is imperative to quickly recognize the condition. Sometimes the airspeed indicator will show substantially less than normal and the airspeed will reduce in the climb. The natural—but incorrect—response is to lower the nose. In this situation, maintaining proper pitch attitude to climb is vital. The airspeed will continue to reduce as you climb, and at about 1,000 feet AGL the PFD attitude and heading indications will be Red-X due to the reduced airspeed indication. As soon as you suspect a blocked static port, try switching to an alternate static source. Know the location of the alternate static air control in your airplane and learn how it works.

On the initial climb-out after takeoff, it is also good practice to note and call out passing through a pre-determined altitude above ground level (AGL) a couple of minutes after takeoff and ideally before entering the clouds (e.g., "2,000 feet"). If your primary and backup instruments are not showing the altitude and airspeed you normally expect to see at that point, you might have partially blocked static system ports. This AGL check and call-out is also a good time to verify that no fuel is siphoning out from the fuel caps, etc. If indications suggest a static system blockage, try switching to an alternate static air source and consider landing to correct the problem.

In flight, if airspeed or altitude anomalies consistent with an obstructed pitot or static line are observed, the pilot should recognize that the PFD's attitude indication will soon be compromised. If in IMC, immediately use the backup attitude indicator to fly the airplane and turn pitot heat ON if icing is suspected. If at any time there is suspicion of an obstructed pitot or static line, use the backup attitude indicator until the situation is resolved.

If the pitot tube becomes blocked in flight, the most common cause is icing. In-flight indications of a blocked pitot tube are typically:

- 1) All airspeed indicators incorrectly show zero (or close to zero);
or
- 2) Airspeed in level flight does not change in response to changes in power or drag and airspeed indications act like an altimeter (decreasing in a descent and increasing in a climb, exactly the opposite of normal behavior).

Airspeed going to zero is by far the most common symptom of a blocked pitot tube.

If you see either of these indications of a blocked pitot tube, the first thing to do is turn on the pitot heat to remove any ice blockage. This will quickly restore the attitude and airspeed indications on the PFD systems (it takes about 40 seconds to recover after the pitot pressure is restored).

To maintain proper aircraft attitude during the event (and if the heated pitot does not work), use the outside horizon if possible, or use the backup attitude indicator to continue safe flight. The autopilot attitude source is also independent of the PFD's attitude indicator and may be another means to maintain level flight. Use the autopilot carefully and constantly monitor its performance against other flight instruments.

If in flight you suspect blocked static ports (probably due to icing), try switching to the alternate static air source. If the static air sources are blocked, recognize that the readout from the transponder and reports from ATC will be in error because of the blocked static system.

If GPS altitude is available on your GPS navigator, become familiar with how the GPS altitude is displayed. Although it can be in error, it might be your only source of altitude information (WAAS GPS altitude is reasonably accurate).

If an instrument approach is necessary, consider a precision approach that will permit vertical guidance with less reliance on the barometric pressure altitude indications.

6.2. Frequent or Persistent CROSS CHECK ATTITUDE Annunciation

Refer to alternate attitude, airspeed, altitude, and heading sources for primary flight information. Consider the following:

CROSS CHECK ATTITUDE

1. Reference standby mechanical attitude indicator.
2. Turn Pitot heat ON.
3. Consider exiting IMC.
4. Land as soon as practicable

For a detailed explanation of when and why the PFD may display a CROSS CHECK ATTITUDE annunciation, either momentarily or persistently, *see Chapter 4, Section 4.1. Air Data, Attitude and Heading Reference System (ADAHRS).*

6.3. Difference Detected Between the PFD and Mechanical Attitude Indicators

Once diagnosed, ensure the correct attitude source is the only one referenced during the remainder of the flight.

Compare Alternate Sources of Available Attitude, Airspeed, and Attitude

1. Compare all available sources of attitude, airspeed, and attitude information to diagnose a faulty indicator.
2. Consider exiting IMC.
3. Land as soon as practicable .



Figure 6-1
Powering Off the
PFD

6.4. Abnormal Shutdown Procedure

The PFD is typically powered through an PFD master switch that is connected to the aircraft's Battery bus. Normally, the PFD will power down when the PFD Master switch is turned OFF or when aircraft power is removed when on the ground. To force the PFD to power down, the following procedures are provided.

Shutdown PFD (on ground)

1. PFD Master switch OFF
2. Press and hold the REV Button until the display turns off (**Figure 6-1**)

Or

1. Press the MENU Button.
2. Rotate the Right Knob to the POWER SETTINGS Menu page
3. Press the SHUT DOWN Menu Key. The power down sequence initiates, and a power down message displays

A powering off annunciation displays indicating that the unit will shut down in 5 seconds. The pilot can press any control to abort the power-down sequence.

Power On Manually

- Press and hold the REV Button until the PFD powers on.

6.5. Loss of Aircraft Electrical Power

In the event that aircraft generated power is degraded or fails, the PFD will automatically switch to its own dedicated battery (Figure 6-2). When continued safe operation depends on the PFD, **UNRESTORABLE LOSS OF EXTERNAL POWER IS AN EMERGENCY SITUATION**. The aircraft should divert to the nearest suitable airport.

Loss of or Degraded Aircraft Power or ON BAT Annunciation

1. Electrical SystemFollow AFM procedures to restore power
2. If unable to restore powerLand as soon as possible

The internal battery will normally provide between 30-60 minutes of operation at approximately 20°C and warmer. At extreme cold temperatures, operation of the internal battery is not assured.

When on battery the auto backlight intensity level defaults to 40% and manual backlight intensity is limited to 70%. Changing the backlight intensity will affect the battery duration, which is reflected in the % remaining indication.

A fully charged battery will indicate a charge level of 99% for some time before beginning to discharge. The charge level will steadily decrease when below 95%, with a slight acceleration as the battery nears 0%.

The “ON BAT” annunciation, along with the estimated battery charge remaining, is displayed whenever the system is operating on battery.



Figure 6-2
Battery Charge Remaining

 **NOTE**

When operating on the internal battery, the display backlight intensity is limited to a value of 70.

 **NOTE**

Setting the brightness to a value of greater than 40% will reduce the battery operation time to less than 30 minutes.

 **WARNING**

When fully charged, the internal battery will power the PFD to provide ADAHRS and emergency RSM GPS position (if enabled) for approximately 30 minutes. When continued safe operation depends on the PFD's primary flight data, **UNRESTORABLE LOSS OF EXTERNAL POWER IS AN EMERGENCY SITUATION**. The pilot should follow the electrical failure checklist in the Aircraft Flight Manual land as soon as possible.

 **CAUTION**

During situations where a high electrical demand is placed on the aircraft electrical system, electrical transients that cause aircraft voltage to drop below 9.0V momentarily or 12.3V for 2 minutes (14V electrical system) or 18.0V momentarily or 24.6V for 2 minutes (28V electrical system) will cause the PFD display to automatically switch to its internal battery.

This will be accompanied by an ON BAT annunciation.

The ON BAT annunciation should extinguish shortly after the electric transient demand goes away. If the ON BAT annunciation does not extinguish, then an aircraft power source failure has most likely occurred.

6.5.1. Overvoltage Protection

In the event of an overvoltage condition in the aircraft's electrical system, (greater than 33 volts) the PFD will automatically switch to its battery power and continue to operate without any pilot action. Operation from the aircraft electrical system will not be possible while the overvoltage condition is present. When aircraft power decreases below 33 volts, pilot action is required to manually switch from the PFD battery power.

Restore Aircraft Power to the PFD

1. Press the MENU Button and rotate the Right Knob to the POWER Settings page
2. Press the EXT PWR Menu Key
3. Press the MENU Button to exit

6.6. GPS Failures and RSM Emergency GPS Use¹

Position and flight plan data for the PFD is provided from aircraft panel-mounted GPS equipment. The PFD may be configured to receive data from one or two external GPS receivers. In addition, if all aircraft GPS receivers fail, the RSM's emergency GPS receiver will provide position data if enabled by the installer.

The Basemap will follow an automatic position reversion scheme to determine which GPS is used to provide position data to the map. The primary GPS is always the one selected by the pilot using CDI Navigation Source Select Button. If the selected GPS fails, the PFD automatically switches to the other aircraft's GPS (if installed) and will annunciate GPS# REVERSION, where # represents the GPS source providing the position data (**Figure 6-22**).

1. Not available with the Pilot PFD

NOTE

When airborne, if the PFD's input voltage is below the 12.8V (14V Electrical System) or 25.6V (28V Electrical System) automatic battery transition threshold, and EXT PWR is selected through the POWER SETTINGS Menu, the PFD will automatically remain connected to its internal battery.



Figure 6-3
External Power Voltage Status



Figure 6-4
Battery Status

If all aircraft panel-mounted GPS receivers experience a failure, the RSM Emergency GPS receiver will provide position data that is shared among all EFDs. In addition, a text alert is presented at the bottom center of the Navigation Display annunciating RSM GPS REVERSION EMER USE ONLY (**Figure 6-23**). This “sharing” feature permits any EFD (as configured by the installer), to receive and display the RSM GPS position data, thus assuring continuous navigational awareness to the pilot. In this case, the Basemap data is approved for emergency use only

Whenever the map has reverted to an alternate position source, all map features and capabilities are retained, including the display of the flight plan from the selected panel-mount GPS. However, when the selected GPS is no longer providing position data, the flight plan is displayed without an active (magenta) leg. The flight plan and Basemap data from each of the aircraft’s GPS receivers is retained independently. If two external GPSs were connected prior to failure of both, and if each had a different flight plan at the time of failure, both retained flight plans remain available to the pilot and may be selected using the PFD’s Navigation Source Select Button.

In the unlikely event that there is a complete loss of all GPS data to the EFD, including failure of the RSM GPS receiver, all mapping information would be removed from the EFD display.

6.7. Power Override

In the event that the pilot wishes to override the PFD's automatic power configuration, proceed as follows:

Power Override

1. MENU“POWER SETTINGS” Page

To switch FROM aircraft power to Internal Battery:

2. “BATTERY” LINE SELECT KEY.....PRESS

To switch FROM internal Battery TO aircraft power:

3. “EXT PWR” LINE SELECT KEYPRESS

View External Voltage Status

1. Press the MENU Button.
2. Rotate the Right Knob to the POWER SETTINGS Menu displays.
3. The EXT PWR Menu Key (**Figure 6-3**) displays the external power voltage.
4. Press the MENU Button to exit.

View Internal Battery Status

1. Press the MENU Button.
2. Rotate the Right Knob to the POWER SETTINGS Menu displays.
3. The BAT Menu Key (**Figure 6-4**) displays the current Battery Status as either Charging or a Percentage of Charge.
4. Press the MENU Button to exit.

NOTE

When airborne, if the PFD's input voltage is below the 12.8V (14V Electrical System) or 25.6V (28V Electrical System) automatic battery transition threshold, and EXT PWR is selected through the POWER SETTINGS Menu, the PFD will automatically remain connected to its internal battery.



Figure 6-3
External Power Voltage Status



Figure 6-4
Battery Status

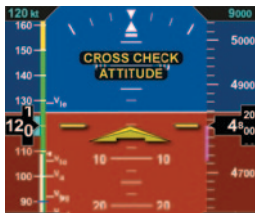

Figure 6-5
Attitude Degraded Performance

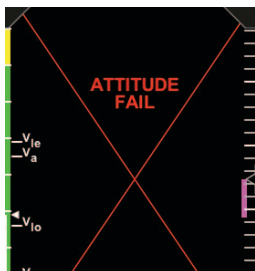

Figure 6-6
Attitude Failure

NOTE

When the PFD's AHRS is reset in flight, it performs an abbreviated initialization.

The AHRS Reset is considered complete when the PFD's attitude and heading is once again displayed, stable, and correct with respect to the horizon or standby attitude indicator.

6.8. In-Flight AHRS Reset

In the unlikely event the PFD determines a potential degradation of attitude information, a warning annunciation, CROSS CHECK ATTITUDE, is shown (**Figure 6-5**). If the attitude pitch or roll data become invalid, a red X and the textual annunciation of ATTITUDE FAIL replaces the Attitude Indicator, and all aircraft roll, pitch, and slip information is removed from the Attitude Display (**Figure 6-6**). Use alternate, mechanical flight instruments for primary flight information and reset the PFD's AHRS as soon as possible.

During the In-Flight AHRS Reset, the aircraft should not be subjected to excessive turn rates. Typical in-flight Resets will take approximately 30 seconds, but can take longer if the reset is initiated while banked or maneuvering.

Perform an In-Flight AHRS Reset

1. Maintain straight and level flight.
2. Consider exiting IMC.
3. Fly by visual reference or by standby instruments.
4. Disconnect the autopilot.
5. Press the MENU Button.
6. Rotate the Right Knob to display the GENERAL SETTINGS A Menu page.
7. Press the AHRS RESET? Menu Key (**Figure 6-7**).
8. A confirmation message displays, prompting the user to confirm the reset request (**Figure 6-8**).
9. Press the AHRS Menu Key again to confirm the AHRS reset. The AHRS reset is performed, and the confirmation messages clears.
10. Press the MENU Button to exit.



Figure 6-7
AHRS Reset Menu Key



Figure 6-8
AHRS Reset Confirmation Message

NOTE

Pressing any other key, button, or knob cancels the AHRS reset and clears the confirmation message.



Figure 6-9
Operating in GPSS Mode



Figure 6-10
GPSS in Wings Level Mode

6.9. GPSS Operation, Annunciations, and Autopilot Modes¹

The Pro PFD offers GPSS. Three modes, Enabled, Wings Level, and Disabled, are possible and annunciated in the PFD's Navigation Display. When enabled, the configured GPS source not only provides the Basemap and flight plan data, but also passes GPSS as the heading input to a configured autopilot. When engaged, a configured autopilot will interpret GPSS commands as heading inputs and follow the active GPS flight plan, including anticipated turns, if provided. The GPSS Enabled mode is indicated by a green GPSS Hot Key label and a GPSS1 with an inverse A placed next to the Selected Heading Field to describe the source (Figure 6-9).

If GPSS is enabled and the GPS source is lost or changed, the GPSS mode automatically changes to the Wings Level mode and annunciates as shown in Figure 6-10.

NOTE

When using GPSS with combined GPS / VLOC navigators (e.g. GNS 430/530), VLOC may be selected as the navigation source while GPSS is engaged. To avoid confusion, note the PFD Selected CDI Navigation Source controls the CDI and the autopilot's navigation and approach modes when engaged. GPSS reflects the heading commands required to navigate the active flight plan leg and controls the autopilot's heading mode when engaged. Complete understanding of autopilot mode functions and their proper selection is recommended.

1. Not available with the Pilot PFD

The Wings Level mode removes roll steering inputs to the autopilot, causing the aircraft to roll wings level, and displays a red slash through the annunciated A HDG and GPSS# source. The amber GPSS Hot Key label requires pilot action. If this occurs, do the following:

When GPSS Automatically Changes to Wings Level Mode

1. Check the configured GPS source.
2. Check the PFD Selected CDI Navigation Source.
3. If the selected GPSS source is restored or changed and GPSS is still desired, press the GPSS Hot Key to activate GPSS (The GPSS Hot Key label turns inverse green).

Disable GPSS

1. Adjust the PFD HDG bug as desired.
2. Check or set the Autopilot Control Panel modes as desired.
3. Press the GPSS Hot Key until the Hot Key label turns gray (**Figure 6-11**).



Figure 6-11
GPSS Disabled

NOTE







The configured GPS source must provide an active flight plan (or Direct-To waypoint) for GPSS to remain engaged or to be restored.

When the PFD navigation source is changed to another configured GPS or VLOC source for longer than 2 seconds, the GPSS Enabled mode will change to Wings Level. The pilot must then press the GPSS Hot Key to restore or disable GPSS, as desired.

NOTE

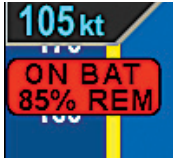
When the GPSS is enabled and the autopilot is engaged in the Heading (HDG) mode, disabling the GPSS will cause the autopilot to follow the HDG Bug.

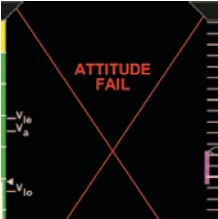
6.10. Warning, Caution, and Advisory Summary

 WARNINGS		
		<p>Presented when the PFD is operating on the internal battery. The countdown timer begins at 15 seconds and is then replaced by the ON BAT annunciation with the battery's % charge remaining.</p>
<p>Figure 6-12 Battery Countdown</p>	<p>Figure 6-13 Battery Charge Remaining</p>	<p style="text-align: center;">  NOTE </p> <p><i>If the battery temperature is less than 0°C, the countdown timer will begin at 10 minutes.</i></p>
		<p>Presented when the PFD has determined that the associated function is invalid or failed and should not be used. The data is removed from the display and replaced by a red X over the affected display feature.</p>
<p>Figure 6-14 Attitude Fail</p>	<p>Figure 6-15 Direction Indicator Fail</p>	

WARNINGS

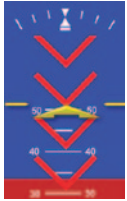

Figure 6-16
Chevrons indicate Pitch Down

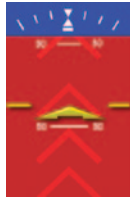

Figure 6-17
Chevrons indicate Pitch Up

When the Attitude Indicator display extreme pitch up or extreme pitch down attitudes, the red chevrons indicate the direction to restore level flight.

Table 6-1
Warning Annunciations

CAUTION

Figure 6-18
Cross Check Attitude

Presented when the PFD AHRS internal integrity monitor determines that attitude is potentially degraded. When a CROSS CHECK ATTITUDE annunciation is presented, the pilot should cross check attitude, airspeed, and altitude indications with other sources of primary flight information.

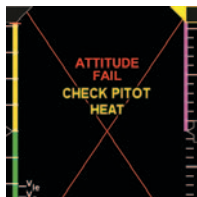

Figure 6-19
Check Pitot Heat

The CHECK PITOT HEAT annunciation accompanies the ATTITUDE FAIL annunciation and is presented when the software detects an obstruction in the pitot system that could potentially degrade the attitude solution. This annunciation is removed when the detected condition is resolved, which would be followed by an automatic AHRS reset. A GPS is required for this monitor to be enabled.

CAUTION

Figure 6-20
GPS Invalid



Figure 6-21
RSM GPS



Figure 6-22
GPS Reversion



Figure 6-23
GPS Reversion Emergency

Presented when a configured GPS source's data is invalid or unavailable. GPS# or RSM REVERSION annunciations indicate the current GPS Basemap source¹



Figure 6-24
GPS Integrity Flag

Presented when the PFD's Selected CDI Navigation Source is a GPS and that GPS is sending an Integrity alert. See the GPS AFMS for more information¹



Figure 6-25
Altitude Caution

Presented to indicate the aircraft is reaching (steady) or deviating (flashing) from the preset altitude. May be accompanied by a one-second steady tone from an optional tone generator¹.



Figure 6-26
Decision Height Caution

Presented when a connected radio altimeter indicates it has reached the altitude set by the pilot. See the Radio Altimeter AFMS for more information¹



CAUTION

Figure 6-27
GPSS Source Lost/Changed

Presented when the previously enabled and valid GPSS source is lost or has changed. Indicates the GPSS Wings Level mode¹.

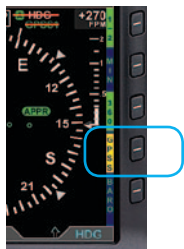

Figure 6-28
Data Link Weather Data Error

Data Link Weather product data not received for 30 seconds after an error is detected¹.



Figure 6-29
Minimums Caution

The Minimums Markers are presented on the altitude tape and the Selected Minimums Field is presented on the Attitude Display when the MIN Hot Key is selected. The markers include three components – a green triangle at 500 ft. above minimums, a hollow yellow triangle at 100 ft. to 200 ft. above minimums, and a red and yellow striped triangle at the selected minimums¹.

The MIN legend in the Selected Minimums Field turns inverse amber to alert the pilot whenever the aircraft is at or below the selected minimums setting. When configured, an optional Sonaltert generates a one-second stuttered tone¹.

Table 6-2
Caution Annunciations

1. Not available with the Pilot PFD

ADVISORY

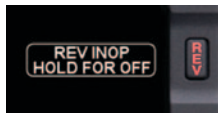

Figure 6-30
REV Button Off

Presented when the REV Button is pressed.



Figure 6-31
GPSS On

Presented when GPSS is enabled and the GPS source is valid. Either GPSS1 or GPSS2 may be annunciated, depending on selection and the number of configured GPS navigators. This also indicates the autopilot heading source¹.

NOTE

GPSS will always reflect the GPS Basemap source in the Navigation Display and follow its source.

 **ADVISORY**

Figure 6-32
GPS Annunciations

Associated with the GPS and the Selected CDI Navigation Source. See the GPS AFMS for more information¹.

 **NOTE**

These annunciations do not display for RS232-based GPS.



Figure 6-33
Traffic Enabled

Indicates the traffic sensor is enabled¹.



Figure 6-34
WX-500 Strike Rate

WX-500 Strike display mode selected. The rate indicates the approximate number of lightning strikes detected per minute¹.



Figure 6-35
WX-500 Cell Rate

WX-500 Cell clustering display mode selected. The rate indicates the approximate number of lightning strikes detected per minute¹.



Figure 6-36
WX-500 Self-Test

Self-test mode annunciation that replaces WX-500 Strike/Cell rate information¹.

 **ADVISORY**

Figure 6-37
Data Invalid or Unavailable

A horizontal red line through any legend indicates that the data is invalid or unavailable¹.



Figure 6-38
Navigation Source Invalid or Unavailable

A horizontal red line through the Selected CDI Navigation Source indicates that the data from the source is invalid or unavailable¹.



Figure 6-39
GPSS Disabled

GPSS Hot Key label with a blue background and gray letters indicate that the GPSS is disabled¹.

Table 6-3
Advisory Annunciations

1. Not available with the Pilot PFD

Page Intentionally Left Blank

Chapter 7

Appendices

7.1. Operating Limitations

Refer to the latest version of the [Airplane Flight Manual Supplement \(AFMS\)](#), Aspen Avionics document 900-00008-001 for the limitations that apply to your specific aircraft installation.

The AFMS and this Pilot's Guide must be carried in the aircraft and be immediately available to the pilot while in flight.

For installations that include the optional EFD1000 MFD and/or the EFD500 MFD, the [EFD1000/500 MFD Pilot's Guide](#) 091-00006-001, must be carried in the aircraft and be immediately available to the pilot while in flight.

7.2. Software Versions and Serial Number

The system software versions for the Main Application Processor (MAP), the Input-Output Processor (IOP), and the unit Serial Number (S/N) are recorded in the SYSTEM STATUS page of the Menu.

The ACU software version and serial number are recorded on a label affixed to the ACU unit.

 **NOTE**

*To view the software version, press the MENU Button and rotate the Right Knob to the Systems Status page. The "MAP VER:" (Main Application Processor Version) displays the software version your unit is operating (see **Figure 7-1**).*



Figure 7-1
View Main Application Processor
Software Version

View the Main Application Processor Software Version

1. Press the MENU Button.
2. Rotate the Right Knob to the SYSTEM STATUS Menu page.
3. The MAP VER Menu Key displays the current Main Application Processor Software Version (**Figure 7-1**).
4. Press the MENU Button to exit.



Figure 7-2
View Input/Output Processor
Software Version

View the Input/Output Processor Software Version

1. Press the MENU Button.
2. Rotate the Right Knob to the SYSTEM STATUS Menu page.
3. The IOP VER Menu Key displays the current Input/Output Processor Software Version (**Figure 7-2**).
4. Press the MENU Button to exit.



Figure 7-3
View Unit Serial Number

View the Primary Flight Display Unit's Serial Number

1. Press the MENU Button.
2. Rotate the Right Knob to the SYSTEM STATUS Menu page.
3. The S/N Menu Key displays the unit's serial number (**Figure 7-3**).
4. Press the MENU Button to exit.

7.3. Evolution Databases

The Evolution Flight Display System (EFD1000 PFD with EFD1000/500 MFD) includes two separate databases loaded on a microSD card; one from Jeppesen and one from Seattle Avionics Software.

Separate data subscriptions are required from both Jeppesen and Seattle Avionics Software to maintain the currency of the data for the EFD1000/500 MFD.

For aircraft configured with a PFD only:

- A microSD card (loaded with only the Jeppesen database) is provided with the purchase of Evolution Synthetic Vision option. The Seattle Avionics database is not required.

For aircraft configured with multiple EFDs; PFD and MFD(s):

- The MFD requires both Jeppesen and Seattle Avionics Software databases for moving map, terrain, charts, and synthetic vision functions to operate correctly.
- Whenever the Evolution Synthetic Vision option is installed, the microSD card is compatible with either the PFD or the MFD and may be interchanged.

The Evolution system uses a single database configuration in both the PFD and the MFD products. A microSD card (loaded with both Jeppesen and Seattle Avionics databases) is provided with each Evolution EFD1000/500 MFD.

7.3.1. Jeppesen Database

The Jeppesen database features the following data types:

- **NavData®** Airports, runways and runway information, frequencies, nav aids, controlled and restricted airspace.
- **Obstacle Data** Depiction of the location and height of man-made obstacles that extend above the ground.

NOTE

The PFD only requires a preloaded microSD card to support the Evolution Synthetic Vision (ESV) option when installed. Otherwise, the PFD does not require a microSD card.

NOTE

For aircraft configured with multiple EFDs and the Evolution Synthetic Vision option is installed, the microSD card data configuration is the same for either the PFD or the MFD and is interchangeable between the displays.

The PFD can only read the Jeppesen database whenever the ESV option is installed.

NOTE

When configured with the ESV option, refer to the Evolution Synthetic Vision Pilot's Guide Supplement, 091-00031-001.

 **NOTE**

Aspen recommends that Aspen customers maintain current data on their Evolution Displays.

- **Cultural Data** Contains boundary and reference information for countries, other major political subdivisions, large water bodies, coastlines, time zones, and other physical and political features.
- **Terrain Data** Depicts the contours and shapes of the surface of the earth.

7.3.1.1. Jeppesen Subscription

Jeppesen provides new Aspen customers a complimentary trial subscriptions for three consecutive months (three 28-day cycles) of Jeppesen NavData® updates at no charge. A Jeppesen database is pre-loaded onto the microSD card that is shipped with the Evolution Flight Display unit.

Thereafter, the data must be updated via an active Jeppesen data subscription. NavData®, obstacle, cultural, and terrain data are combined into a single update which is delivered via *Jeppesen Services Update Manager (JSUM)* every 28 days.

To activate your complimentary Jeppesen data subscription

1. Go to www.aspenavionics.com/customerport
2. Click the **Register** button on the login screen and fill out the easy-to-follow registration form

The registration form consists of the following headings:

- *Owner & aircraft Information*
- *Aspen Product Information*
- *Register for Jeppesen data*
- *Set Up Your Customer Port Login*

Aspen Avionics will automatically forward your Evolution Flight Display product registration information to Jeppesen for activation of the complimentary service.

You will receive a confirmation email directly from Jeppesen indicating service activation as well as instructions on how to use the Jeppesen Services Update Manager (JSUM). Although we make every effort to turn the registrations around very quickly, the entire process may take up to 3-4 days

If you already have a login and password and need to register an additional Evolution Flight Display unit

1. Login to the Customer Port at www.aspenavionics.com/customerport.
2. Click on **Register Your Product** link on the sidebar to register additional Aspen Products.

7.3.1.2. Monthly Jeppesen Updates

The Jeppesen database updates are located in the *Jeppesen Services Update Manager (JSUM)*. JSUM must be downloaded onto your computer to obtain updates. A compatible computer with the ability to write to a microSD card is required.

To download the Jeppesen Services Update Manager (JSUM)

1. Go to www.jeppesen.com.
2. Under *Downloads / Quick Links*, click on the *Jeppesen Services Update Manager (JSUM)* button.
3. From the *Technical support- Jeppesen Services Update Manager (JSUM)* page, under the *User Guide* button, click on the highlighted *Download JSUM v #.#.#* to download JSUM onto your computer.

For additional information, click on the *Troubleshooting* or *FAQs* button, or contact *Jeppesen Customer Service (800-621-5377)*.

Overview on downloading the monthly Jeppesen Update

1. Insert the card in your computer's card slot.
2. Start the JSUM application and login to your account using the credentials provided to you by Jeppesen.

3. Click on the service you want to download to the microSD card.
4. Click on the **Start** button in JSUM to initiate the download.

For complete detailed instructions, refer to jeppesen.com. Once the download is completed with the latest Jeppesen data, download the latest Seattle Avionics data.

7.3.2. Seattle Avionics Software Database

Seattle Avionics Software Database applies to the MFD only

The Seattle Avionics Software database features the following data types:

- Instrument Approach Procedure (IAP) charts
- Standard Instrument Departure (SID) Procedures
- Standard Terminal Arrival Route (STAR) Procedures
- Airport Diagrams
- Radar Instrument Approach Minimums
- IFR Takeoff Minimums
- Obstacle Departure Procedures (ODP)
- IFR Alternate Minimums

7.3.2.1. Seattle Avionics Subscription

Seattle Avionics Software provides new Aspen customers a complimentary trial subscription for three consecutive months (three 28-day cycles) of Seattle Avionics ChartData™ updates at no charge. The Seattle Avionics ChartData™ database is pre-loaded on the microSD card that is shipped with your Evolution Flight Display unit. Thereafter, the data must be updated via an active Seattle Avionics Software data subscription.

To activate your complimentary Seattle Avionics Software data subscription

1. Go to www.seattleavionics.com/aspen
2. Create New Account by typing in the required information then click on the **Create Account** button.
3. Download the **Data Manager** to your computer.



CAUTION

- Do not expose the cards to electrostatic discharge or electrical interference.
- Keep the cards out of direct sunlight.

For complete detailed instructions, click on *How to download and install new data* or contact *Seattle Avionics Technical Support Staff (425-806-0249)*.

7.3.2.2. Seattle Avionics Software Updates

The Seattle Avionics Updates are located in the *Seattle Avionics ChartData Manager*. The *Data Manager* must be downloaded onto your computer to obtain updates from the *Seattle Avionics ChartData Manager*. A compatible computer with the ability to write to a microSD card is required.

Overview for downloading the Seattle Avionics Updates

1. Insert the card in your computer's card slot.
2. Start the *Data Manager* application and login to your Seattle Avionics account.
3. From the *Seattle Avionics ChartData Manager*, select Aspen
4. Click on the *Download Now* button to initiate the download.

For complete detailed instructions, refer to seattleavionics.com/aspen and click on *How to download and install new data* or contact *Seattle Avionics Technical Support Staff (425-806-0249)*.

Once the microSD card is updated with the latest Jeppesen data and Seattle Avionics data, the card is ready for use.

7.4. MicroSD Card

This section contains the instructions for inserting the preloaded microSD card into the Evolution Flight Display unit. Each unit that uses the database must have a microSD card (**Figure 7-4**).

Figure 7-4
MicroSDHC (Secure Digital High Capacity) Card
Label side facing up



NOTE

Each new MFD unit comes with a microSD card provided by Aspen or Jeppesen. The card is specially formatted and preloaded with the Jeppesen NavData® and the Seattle Avionics ChartData™.

Only microSD cards received from Aspen Avionics or Jeppesen may be used. Use of any other card can adversely affect system operation or performance and is NOT AUTHORIZED

NOTE

Replacement or additional cards supplied from Jeppesen are preloaded with terrain data only and must be updated as described in Sections 7.3.1 and 7.3.2 before use.



Figure 7-5
MicroSD Card Slot Locations

CAUTION

It is possible to jam the card between the bezel and the outer edge of the card slot. If the card does not slide in smoothly, something is wrong. Make sure the card is in the card slot and oriented correctly before fully inserting it into the bezel.

Lost or misplaced microSD card? Contact *Jeppesen Customer Service (800-621-5377)* or email captain@jeppesen.com to purchase a replacement or additional microSD card(s) pre-loaded with terrain data.

7.4.1. Loading the microSD Card into the EFD Unit

The microSD card slot on the EFD is a small horizontal slot located on the bottom center part of the bezel (Figure 7-5). The slot is spring-loaded with an integral locking mechanism. Pushing the card in once locks the card in place. Pushing it again releases the locking mechanism for removal.

7.4.2. Card Installation Procedure and Operational Check

Installation Procedure

1. Remove the microSD card from the packaging
2. Slide the microSD card into the unit's card slot (Figure 7-5) with the metal contacts facing down.

CAUTION

Ensure the card label side is facing up and the metal contacts are facing down towards the unit. Do not force the card. The card only goes one way.

3. Press the card against the spring tension until it is fully inserted, then slowly release the pressure. The card will lock into place

Operational Check after Installing the microSD card

1. Turn on the EFD unit(s) and check the Confirmation Screen for validity dates of the Jeppesen Database and the Charts Database (Figures 7-6 and 7-7).

2. Select the functions that use the databases (moving map, terrain, charts, and synthetic vision).
3. Verify the functions can be accessed.

Database Confirmation Screen

The Database Confirmation Screen is presented at system startup and displays the validity dates of the currently loaded:

- Jeppesen Database and the
- Seattle Avionics Software Charts Database (**Figures 7-6** and **7-7**).

At startup, the pilot must acknowledge this operational limitation and the validity dates on the Database Confirmation Screen by pressing either the Left or Right Knob.

7.4.3. Removal Procedure

microSD Card Removal

1. Have a suitable packaging available to accept and protect the microSD card.
2. Press the card against the spring tension, then slowly release the pressure.
3. When the card is unlocked, grasp the card with the thumb and forefinger and remove the card.
4. Place the microSD card in the packaging.



CAUTION

It is possible to push the card in with a fingernail and then suddenly release it, ejecting the microSD card out of the card slot. If the card is dropped, keep in mind that it can be resting on its side.

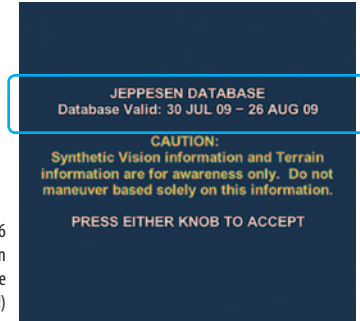

Figure 7-6
PFD Confirmation Screen
Jeppesen Database
(ESV Option Installed)



NOTE

*Whenever a reloaded microSD card (loaded with both databases) is inserted into the PFD, the PFD can only read the Jeppesen database (see **Figure 7-6**).*

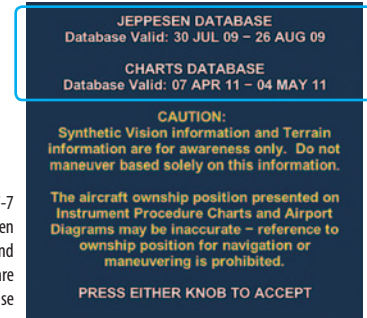

Figure 7-7
MFD Confirmation Screen
Jeppesen Database and
Seattle Avionics Software
Charts Database

7.5. Specifications

7.5.1. Primary Flight Display Unit (PFD)

GENERAL SPECIFICATIONS	
Width	3.50 in. (Measured at Bezel)
Height	7.00 in. (Measured at Bezel)
Can Depth	4.15 in. (Rear of Bezel to Rear of Can)
Overall Depth	6.35 in. (Knob to Rear Pressure Fitting)
Weight	2.9 lbs. (with Mounting Bracket)
Display Type	6.0 in. Diagonal TFT Active Matrix LCD (400x760)
Display Colors	32,768
Face	Anti-Reflective Coated Glass
Backlight	High Intensity White LED
Rotary Knobs	Optical Encoder with Momentary Press
Dimming	Manual & Automatic (Front Bezel Mounted Sensor)
OPERATIONAL SPECIFICATIONS	
Operating Temp	-20°C to +55°C
Storage Temp	-55°C to +85°C
Max Un-Pressurized Operating Altitude	35,000 ft.
Max Pressurized Operating Altitude	55,000 ft.
Cooling	Integral Fan
Max Humidity	95% at 50°C

Input Voltage	+8 to +32 Volts DC
Max Current	2.4 Amps @ 28 VDC
	4.8 Amps @ 14 VDC
I/O SPECIFICATIONS	
ARINC 429 Inputs	5
ARINC 429 Outputs	1
RS-232 Inputs	5
RS-232 Outputs	3
Pitot / Static	Quick Connect
CERTIFICATION SPECIFICATIONS	
FAA Technical Standard Order	TSO-C2d / ETSO-C2D.....Airspeed Instruments
EASA (European Aviation Safety Agency) ETSO (European Technical Standard Order)	TSO-C3d / ETSO-C3D.....Turn and Slip Instrument
	TSO-C4c / ETSO-C4C.....Bank and Pitch Instruments
	TSO-C6d / ETSO-C6D.....Direction Instrument Magnetic (Gyroscopically Stabilized)
	TSO-C8d / ETSO-C8D.....Vertical Velocity Instrument (Rate of Climb)
	TSO-C10b / ETSO-C10B.....Altitude Pressure Activated Sensitive Type
	TSO-C106 / ETSO-C106.....Air Data Computer
	TSO-C113 / ETSO-C113.....Airborne Multipurpose Electronic Displays
Software	RTCA DO-178B Level C
Environmental	RTCA DO-160E
Categories	See Environmental Qualification Sheet found in the Installation Manual.

Table 7-1
Primary Flight Display Unit (PFD) Specifications

7.5.2. Remote Sensor Module (RSM)

Width	2.65 in.
Length	4.40 in.
Height	1.00 in.
Weight	0.2 lbs.
Input Voltage	Provided by PFD
Max Current	Included in PFD Current

Table 7-2
Remote Sensor Module (RSM) Specifications

7.5.3. Analog Converter Unit (ACU)

Width	5.75 in. (including mounting flange)
Length	4.30 in. (including connector)
Height	1.60 in. (including mounting flange)
Weight	0.8 lbs.
Input Voltage	+10 to +32 VDC
Max Current	0.5 Amps @ 28 VDC 1.0 Amps @ 14 VDC
Interfaces	ARINC-429 and RS-232

Table 7-3
Analog Converter Unit (ACU) Specifications

7.5.4. Operational Specifications

Airspeed Range	Minimum displayed airspeed	20 KIAS
	Maximum displayed airspeed	500 KIAS
Altitude Range	Minimum displayed altitude	-1,600 ft. MSL
	Maximum displayed altitude	51,000 ft. MSL
Vertical Speed Range	Maximum displayed vertical speed rates (tape)	+/-2,000 fpm
	Maximum displayed vertical speed rates (numerical value)	+/- 9,990 fpm
Turn Rate	Maximum displayed turn rate	6.0 °/second
Barometric Pressure Correction Range	28.10 to 30.99 In Hg (946 to 1049 mB)	
Internal Battery	Minimum operating time while on internal battery	30 minutes ¹

Table 7-4
Operational Specifications

-
1. At extreme cold temperatures the internal current limiting protections of the internal battery may cause the battery to shut off and not power the display.

7.6. Glossary

°C	Degrees Celsius	AWOS	Automated Weather Observation System
°F	Degrees Fahrenheit	Back Course	Localizer back course approach where the signal on the back side of the localizer is used for alignment to the runway opposite of normal localizer alignment.
Accuracy	Estimated position accuracy in feet or meters	Battery Time	The time remaining on the battery before it is fully discharged.
A/D	Analog to Digital	BC	Back Course
AC	Alternating Current	Bearing	The compass direction from the current position to the destination.
ACU	Analog Converter Unit	BP	Bearing Pointer
ADC	Air Data Computer	Calibrated Airspeed	Indicated airspeed corrected for installation and instrument errors.
ADI	Attitude Director Indicator	CDI	Course Deviation Indicator
AFMS	Airplane Flight Manual Supplement	CFR	Code of Federal Regulations
AGL	Above Ground Level	CM	Configuration Module
AHRS	Attitude Heading Reference System	Comm	Communication radio
AI	Attitude Indicator	Course	The route taken from the starting position to destination.
AIM	Aeronautical Information Manual	Course to Steer	The recommended direction to steer in order to reduce cross-track error and return to the course line.
AIRMET	Airman's Meteorological Information	Cross Track	The perpendicular distance, left or right, away from the selected course.
Altitude	Elevation above mean sea level		
APPR	Approach		
APT	Airport		
ARC	Partial Compass Rose, arc format (100°)		
ARINC	Aeronautical Radio, Inc.		
ATC	Air Traffic Control		
ATIS	Automatic Terminal Information Service		

Crosstrack Error	The distance the aircraft is off the desired course.	EFD	Evolution Flight Display
CRS	Course	EFIS	Electronic Flight Instrument System
CTS	Course to Steer	Elevation	The height above mean sea level.
dBZ	decibels 'Z' (radar return)	ETA (Destination)	Estimated Time of Arrival. The estimated time you will reach a Go To destination or the final waypoint in a route.
DC	Direct Current	ETA (Next)	Estimated Time of Arrival. The estimated time you will reach a Go To destination or the next waypoint in a route.
Decision Height	A specified height or altitude in the precision approach at which a missed approach must be initiated if the required visual reference to continue the approach has not been acquired. This allows the pilot sufficient time to safely reconfigure the aircraft to climb and execute the missed approach procedures while avoiding terrain and obstacles.	ETE (Destination)	Estimated Time Enroute. The estimated time required to reach a Go To destination or the final waypoint in a route.
Declutter	Reduce the number of basemap symbols displayed on screen.	ETE (Next)	Estimated Time Enroute. The estimated time required to reach a Go To destination or the next waypoint in a route.
Deg	Degree	ETSO	European Technical Standard Order
Desired Track	The desired course between the active "FROM" and "TO" waypoints.	FAA	Federal Aviation Administration
DH	Decision Height	FAF	Final Approach Fix
Distance (Next)	The great circle distance from current location to a Go To destination or the final waypoint in a route.	FD	Flight Director
DME	Distance Measuring Equipment	fpm	Feet Per Minute
DTK	Desired Track	ft	Feet
EASA	European Aviation Safety Agency	GPS	Global Positioning System
		GPSS	GPS Steering
		Ground Track	see Track

Ground Speed	The velocity that the aircraft is travelling relative to a ground position.	LCD	Liquid Crystal Display
GS	Glide Slope or Ground Speed	LDI	Lateral Deviation Indicator
Heading	The direction an aircraft is pointed, based upon indications from a magnetic compass or a properly set directional gyro.	Leg	The portion of a flight plan between two waypoints
Hg	Mercury	LOC	Localizer
HSI	Horizontal Situation Indicator	MAP	Main Application Processor
Hz	Hertz (frequency)	mB	Millibars
IAF	Initial Approach Fix	MFD	Multi-Function Display
IAS	Indicated Air Speed	MHz	Megahertz
IFR	Instrument Flight Rules	MSG	Message
ILS	Instrument Landing System	MSL	Mean Sea Level
IMC	Instrument Meteorological Conditions	NAVAID	Navigation Aid
in Hg	Inches of Mercury	NDB	Non-Directional Beacon
Indicated	Information provided by properly calibrated and set instruments on the aircraft panel.	NXRD	Next Generation Weather Radar
IOP	Input/Output Processor	nm	Nautical Miles
JSUM	Jeppesen Services Update Manager	NRST	Nearest
kHz	Kilohertz	OAT	Outside Air Temperature
KLAS	Knots Indicated Air Speed	OBS	Omni-Bearing Selector
km	Kilometer	PFD	Primary Flight Display
kt	Knots	RMI	Radio Magnetic Indicator
LAT	Latitude	RSM	Remote Sensor Module
		SDHC	Secure Digital High Capacity (microSDHC card)
		TA	Traffic Advisory

TACAN	Tactical Air Navigation System
TAS	True Air Speed
TCAS	Traffic Collision Avoidance System
TERM	Terminal Mode
TIS	Traffic Information System
Track	Direction of aircraft movement relative to a ground position; also Ground Track'
TSO	Technical Standard Order
VAC	Volts, Alternating Current
VDC	Volts, Direct Current
VDI	Vertical Deviation Indicator
VFR	Visual Flight Rules
VHF	Very High Frequency
VLOC	VOR/Localizer
VOR	VHF Omni-Directional Radio Range
VORTAC	VHF Omni-Directional Radio Range and Tactical Air Navigation
VSI	Vertical Speed Indicator
WAAS	Wide Area Augmentation System
WPT	Waypoint
WX	Weather

7.7. Index

Symbols

1/2, Hot Key	2-12
2/2, Hot Key	2-12
360/ARC, Hot Key	2-12

A

ABV, Hot Key	2-13
ADAHRS	4-2-4-7
Attitude	4-3
Free Gyro Mode	4-6-4-7
Heading	4-5-4-6
Pitot Obstruction Monitor	4-4
Advisory	6-22-6-24
Data Invalid or Unavailable	6-24
GPS Annunciations	6-23
GPSS On	6-22
Navigation Source Invalid or Unavailable	6-24
REV Button Off	6-22
Traffic Enabled	6-23
WX-500 Cell Rate	6-23
WX-500 Self-Test	6-23
WX-500 Strike Rate	6-23
AHRS Reset, In-Flight	6-13
Perform	6-14
Aircraft Ownership Symbol	4-26
Air Data, Attitude and Heading Reference System	4-2-4-7
<i>See also</i> ADAHRS	
Airspeed Indicator (Airspeed)	4-10-4-13
Airspeed	4-10
Bug	4-10
Bug, Set	3-16, 4-12
Range	4-11
Airspeed Display	4-13
Tape	4-10
Hide/Display	4-13
Tape and Bug	2-25
Speed Markers	2-25
Altimeter	4-14-4-22
Decision Height	4-21
MINIMUMS	4-17
Altitude	4-14, 4-16-4-17
Alerter	4-14
Alerter, Set	3-15
Bug	4-14
Bug, Set	4-17
Caution	6-20
Display	4-22
Level-Off and Deviation Alert	4-17
Tape	4-14
Hide/Display	4-22
Tape and Alerter	2-26
Trend Vector	4-14

Altitude Display	
Attitude Indicator	2-24, 4-8–4-9
Analog Converter Unit	1-7
Approvals	xxiv
APV (Approaches with Vertical Guidance)	4-61
ARC/360, Hot Key	2-12
Attitude Display	2-22–2-27, 4-8–4-22
Airspeed Indicator	4-10–4-13
Altimeter	4-14–4-22
Attitude Indicator	4-8
Components	2-23
Attitude Fail	6-17
Attitude Indicators, Difference	6-7
Auto Course	4-37
Disable	4-38
Enable	4-37
Select	2-34
Autopilot Integration	4-52–4-63
Autopilot Operations, Typical	4-57–4-63
APPR Mode Operation - GPS or GPS/RNAV APV WAAS Approach	4-61
APPR Mode Operation - ILS Approach with Vectors to Final	4-60
GPS APPR Mode Operation - WAAS GPS Underlay to ILS Approach	
Using Pilot Nav and GPSS	4-62
GPS APPR Mode Operation - WAAS GPS Underlay to ILS Approach	
With ATC Vectors to Final	4-63
HDG Mode Operation - GPS Steering (GPSS)	4-58
HDG Mode Operation - Heading Bug Steering	4-58
NAV Mode Operation - GPS Navigation	4-59
NAV Mode Operation - VLOC Navigation	4-58
Auto Range	
Activate	4-46
Deactivate	4-46
Enable	4-46
B	
Barometer	2-5–2-8, 4-23
Barometric Pressure Adjustment	4-15–4-16
Barometric Pressure, Set	3-8, 4-16
Barometric Pressure Setting Display	4-25
Barometric Units of Measure, Set	4-15
Battery	
Countdown	6-17
Operational	6-17
Status, View	6-12
Bearing Pointers	2-35
Double-Line Bearing Pointer Source, Select	4-41
Nav Sources, Select	3-10
Single-Line Bearing Pointer Source, Select	4-41
Source Select Buttons	2-10
Source Selection	4-39–4-41
BLW, Hot Key	2-13
Brightness Control	5-19
	<i>See also</i> Lighting
BRT ADJUST	2-18
BRT AUTO	2-18
Buttons	xxxii
C	
Cautions	6-19–6-21
Altitude Caution	6-20
Check Pitot Heat	6-19
Cross Check Attitude	6-19
Data link Weather Data Error	6-21
Decision Height Caution	6-20
Explained	xxxiv
GPS Integrity Flag	6-20

GPS Invalid	6-20	Controls	
GPS Reversion	6-20	Knobs	2-4–2-8
GPS Reversion Emergency	6-20	Left Knob Functions	2-5
GPSS Source Lost/Changed	6-21	Right Knob Functions	2-5
Minimums Caution	6-21	SYNC Function	2-6–2-7
RSM GPS	6-20	Controls and Display	2-1–2-38
CDI		Controls	2-4–2-19
Course, Select	4-38	Elements	2-2–2-3
Navigation Source	4-33–4-36	Conventions	xxxix–xxxvi
Radio Mode, GPS	4-35	Color Philosophy	xxxiii
Radio Source, VHF	4-35	Covered Functionality	xxxix
Select	3-10, 4-34	Example Graphics	xxxv
Nav Source Select Button	2-9	Information Covered in this Pilot's Guide	xxxvi
Selected Course	4-38	Pilot Familiarity	xxxv
Source Information Block	4-34	Terminology	xxxix
Source Label	4-34	Warnings, Cautions, Notes	xxxiv
Source Select Button	4-34	Copyrights and Trademarks	xxiii
Check Pitot Heat	6-19	Course Deviation Indicator and Scale	4-32
CHECK PITOT HEAT	4-4	Course Pointer	4-30
Cleaning the Display Screen	2-21	Course Pointer and Deviation Indicator	2-33
Color Philosophy	xxxiii	Covered Functionality	xxxix
Compass	4-27–4-29	CROSS CHECK ATTITUDE	4-3, 6-7, 6-19
360° Compass Mode	4-27	CRS	2-5–2-8
ARC CDI/HSI Compass Mode, Select	4-28	Customizing the EFD1000 PFD	5-1–5-19
ARC Compass Mode	4-27	Customizing the Map	5-11–5-13
Compass Scale	4-26		
Compass Type, Select	4-29	D	
Modes: 360° vs. ARC	2-31	Data Bar	2-28, 4-23–4-25
Select	3-20	Databases	1-8, 7-3
Configuration Module	1-6	Data Invalid or Unavailable	6-24
Configuring V-speeds	5-14–5-18	Data Link Weather	4-66–4-69
		Age Annunciations	4-69

Age, View	4-68	Trio Display	1-3, 1-4
Data Error	6-21	Evolution Weather Receiver	1-7
Legend, Display	4-67	Example Flight	3-5–3-27
NEXRAD Methodology	4-67	Arrival and Approach to Landing	3-22–3-27
Product Age Limits and Update Frequency	4-68	Departure	3-17–3-18
Underlay, Display	3-13, 4-66	En Route	3-19–3-21
Decision Height	4-21	Pre-Departure	3-6–3-16
Alert	4-14	Example Graphics	xxxv
Caution	6-20	External Voltage Status, View	6-12
Declutter		Extreme Pitch	6-18
Settings	5-13		
Deviation		F	
Indicator	4-26	Flight Director	4-9, 4-57
Off Scale Indication	2-34	Flight Plan	4-47
Scale	4-26	Free Gyro Mode	4-6–4-7
Direction Indicator Fail	6-17		
Direction Indicator (Magnetic Compass)	2-31–2-32, 4-26	G	
Display	1-5, 2-20–2-37	GENERAL SETTINGS A	5-1
Attitude Display	2-22–2-27	GENERAL SETTINGS B	5-2
Cleaning the Display Screen	2-21	GPS	
Lighting	2-18	Annunciations	6-23
Document Revisions	iv–v	Failures	6-11
Dual Display	1-2	Integrity Flag	6-20
		Invalid	6-20
E		Reversion	6-20
Electrical Power, Loss of Aircraft	6-9	Reversion Emergency	6-20
Emergency and Abnormal Procedures	6-1–6-24	GPSS 4-53–4-57	
Pitot/Static System Blockage	6-2–6-6	Disable	6-16
Evolution Flight Display (EFD) system	1-1	Enable/Disable	4-54
Dual Display	1-2	Engage	3-19
Single Display	1-2	Hot Key	2-12
System Overview	1-4	Operation, Annunciations, and Autopilot Modes	6-15

Source Lost/Changed	6-21
Wings Level	6-16
Ground Speed	4-23
Ground Track Marker	2-32

H

Hazard Awareness	4-64–4-74
Data Link Weather	4-66–4-69
Lightning	4-64–4-66
Traffic	4-70–4-74
Heading	4-26
Display	4-43
Heading and Heading Bug	4-42
Heading Bug, Set	2-8, 3-9, 4-42
Horizontal Situation Indicator	2-33
Hot Keys	xxxii, 2-11

I

IAS 2-5–2-8	
ILS Approaches	4-62
Examples	3-22–3-27
Information Covered in this Pilot's Guide	xxxvi
Initial Flap Extension Speed Marker	4-10
Instrument Approach Indicators	2-27
Internal Battery Status, View	6-12
Introduction	1-1–1-3

K

Knobs xxxii, 2-4–2-8	
Left Knob Functions	2-5
Right Knob Functions	2-5
SYNC Function	2-6–2-7

SYNC Function, Perform	2-6
Using the Knobs (Example)	2-8

L

Lateral Deviation Indicator	4-49–4-50
Lighting	2-18, 5-19
Lightning	4-64–4-66
Data Link Lightning Symbol	4-65
Underlay, Display	3-13, 3-21, 4-66
WX-500 Cell Symbol	4-65
WX-500 Strike Symbol	4-65
Loss of Aircraft Electrical Power	6-9
LPV Approaches	4-62
LTNG, Hot Key	2-13

M

Main Menu	2-14–2-17
Brightness Control	2-15
Menu Text	2-16
Overview	5-1–5-10
360° MAP SETTINGS	5-3
ARC MAP SETTINGS	5-4
GENERAL SETTINGS A	5-1
GENERAL SETTINGS B	5-2
POWER SETTINGS	5-9
SYSTEM STATUS	5-10
VSPEEDS A	5-5
VSPEEDS B	5-5
XM RECEIVER A	5-6
XM RECEIVER B	5-7
XM RECEIVER C	5-8

Page graphical bar	2-15
Page Name	2-15
Page number and mode	2-15
Using the Menus	2-14–2-17
Access and Navigate	2-16
Edit Main Menu Items	2-17
Map	
Auto Range	4-46
Data Source and Reversion	4-47
Declutter Settings	5-13
Declutter and Range	4-45
Declutter Level, Select	3-11, 4-45
Feature Group & Layer Order	5-13
Flight Plan	4-47
Max Range	5-13
Range, Change	3-12, 4-45
Symbol Display, Set	5-12
Underlays	4-44–4-48
MAP, Hot Key	2-12
MEMS	4-2
Menu Keys	xxxii
Micro Electro-Mechanical Systems	4-2
MicroSD Card	1-8, 7-7
MINIMUMS	4-17–4-20
Adjustment	4-14
Alert	4-14
Caution	6-21
Display/Hide	4-19
MIN, Hot Key	2-5–2-8, 2-12
Set	4-20

N

Navigation	
Information	2-32
Source	4-26
Source Info Block	4-26
Source Invalid or Unavailable	6-24
Source Select Buttons	2-9–2-10
Navigation Display	2-29–2-37, 4-26–4-48
Aircraft Heading Display	4-43
Auto Course	4-37–4-38
Auto Course Select	2-34
Bearing Pointers	2-35
Bearing Pointer Source Selection	4-39–4-41
CDI Navigation Source	4-33–4-36
CDI Selected Course	4-38
Compass	4-27–4-29
Components	2-30
Course Deviation Indicator and Scale	4-32
Course Pointer	4-30
Course Pointer and Deviation Indicator	2-33
Deviation Off Scale Indication	2-34
Direction Indicator (Magnetic Compass)	2-31–2-32
Ground Track Marker	4-48
Heading and Heading Bug	4-42
Horizontal Situation Indicator	2-33
Map Underlays	4-44
Rate of Turn Indicator	2-36, 4-43
Situational Awareness Map	2-37
TO/FROM Indicator	4-31
Vertical Speed Indicator	2-36

Navigation Source	
Select Buttons	
Bearing Pointer Source Select Buttons	2-10
CDI Nav Source Select Button	2-9
NEXRAD Methodology	4-67
Notes	

See also Advisory

Explained	xxxiv
NRM, Hot Key	2-13
Numerical Airspeed Value	4-10
Numerical Altitude Value	4-14
NXRD, Hot Key	2-13

O

Operating Limitations	7-1
Outside Air Temperature	4-23, 4-24
OAT Units of Measure, Set	4-24

P

Pilot Familiarity	xxxv
Pilot PFD	xxxvi
Pitch Scale	4-9
Pitot and/or Static System Failures, Identifying	6-4
Pitot Obstruction Monitor	4-4
Pitot/Static System Blockage	6-2–6-24
Suspected	6-3
Power On Manually	6-8
Power Override	6-12

R

Range Button	2-19
Rate of Turn Indicator	2-36, 4-26, 4-43
Rear Connections	1-5
Remote Sensor Module	1-6
REV Button	2-19
Off	6-22
Right Knob Functions	2-5
RNAV Instrument Approaches	4-61
Roll Scale	4-9
RSM Emergency GPS Use	6-11
RSM GPS	6-20

S

Service Agreement, XM WX Satellite Radio	xxix
Shutdown Procedure, Abnormal	6-8
Single Display	1-2
Situational Awareness Map	2-37
Slip/Skip Indicator	4-9
Software Versions	7-1–7-2
Input/Output Processor Software Version, View	7-2
Main Application Processor Software Version, View	7-1
Specifications	7-3–7-6
Analog Converter Unit	7-5
EFD1000 Display Unit	7-3
Operational	7-6
Remote Sensor Module	7-5
Speed Bands	4-10
Ranges	5-16
Speed Markers	2-25, 4-10
Startup Splash Screen	3-6

SYNC Function	2-6–2-7
System Architecture	1-4
System Overview	1-4

T

Terminology	xxxi–xxxii
Buttons	xxxii
Hot Keys	xxxii
Knobs	xxxii
Menu Keys	xxxii
TO/FROM Indicators	4-26, 4-31
Track Marker	4-26, 4-48
Traffic	4-70–4-74
Altitude Filter	4-73
Change	4-73
Enabled	6-23
Overlay, Display	3-14, 4-70
Symbols	4-70–4-72
Unavailable	4-74
TRFC, Hot Key	2-13
Trio Display	1-3
True Airspeed	4-23

U

Unit Serial Number, View	7-2
UNR, Hot Key	2-13
Using the Menus	2-14

V

Vertical Deviation Indicator	4-49–4-50
Vertical Speed Indicator	2-36, 4-51
Voltage Status, View	6-12
Vspeeds	4-10
Configuring	5-14–5-18
Definitions	5-14–5-15
Initial Flap Extension	5-15
Textual Labels, Enable	5-17
Textual Vspeed Labels, Set	5-18

W

WAAS Approaches	4-61
Warning, Caution, and Advisory Summary	6-17–6-24
Warnings	6-17–6-18
Attitude Fail	6-17
Battery Countdown	6-17
Battery Operational	6-17
Direction Indicator Fail	6-17
Explained	xxxiv
Extreme Pitch	6-18
Warranty	xxv–xxvii
Card	xxvi
Conditions	xxv
Dealer	xxvii
Exclusions	xxv
Exclusive	xxvi
Extension of	xxvii
Incidental Damages	xxvi

Invalidation	xxvi
Limitation of Liability	xxvi
Procedure	xxvii
Remedy	xxv
Transportation Costs	xxvii
Weather Data	xxviii
Weather	
Age Annunciations	4-69
Data Warranty	xxviii
Product Age Limits and Update Frequency	4-68
Wind	
Direction	4-23
Direction Arrow	4-23
Speed	4-23
Speed, Direction, and Arrow	4-24
Wings Level	4-57
WX-500	
Cell Rate	6-23
Self-Test	6-23
Strike Rate	6-23
X	
XM WX Satellite Radio Service Agreement	xxix



Aspen Avionics, Inc.

5001 Indian School Road NE

Albuquerque, NM 87110

Phone: 888-99ASPEN (888-992-7736)

Phone, International: (505) 856-5034

Fax: (505) 314-5440

info@aspenavionics.com

www.aspenavionics.com